

25102 SKF

Radial shaft seals

TYPE: Radial shaft seals, Metal case and a secondary reinforcement in the side face, With spring-loaded sealing slip, Type CRWHA1, material ACM (SKF)

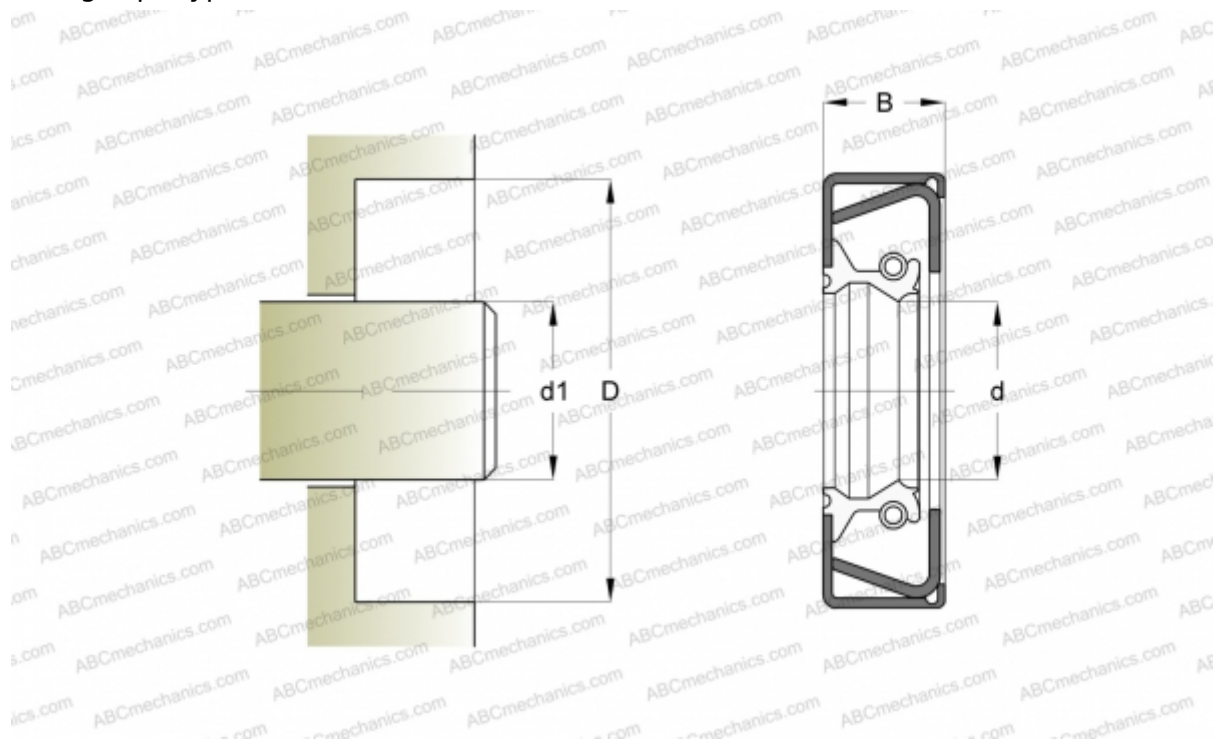

Technical specification

DIMENSIONS, MM

d1	63,500
d	63,500
D	98,450
B	11,913

MANUFACTURER [SKF](#)

INTERCHANGE

CR [CR 25102](#)

CALCULATION DATA

Operating temperature min	-40 °C
Operating temperature max	150 °C
Permissible operating temperature, short periods max	175 °C
Pressure differential max	0,070 Mpa
Maximum shaft surface speed	18,000 m/s