

## 27295 SKF

Radial shaft seals

TYPE: Radial shaft seals, Metal case and a secondary reinforcement in the side face, With spring-loaded sealing slip, Type CRWHA1, material ACM (SKF)

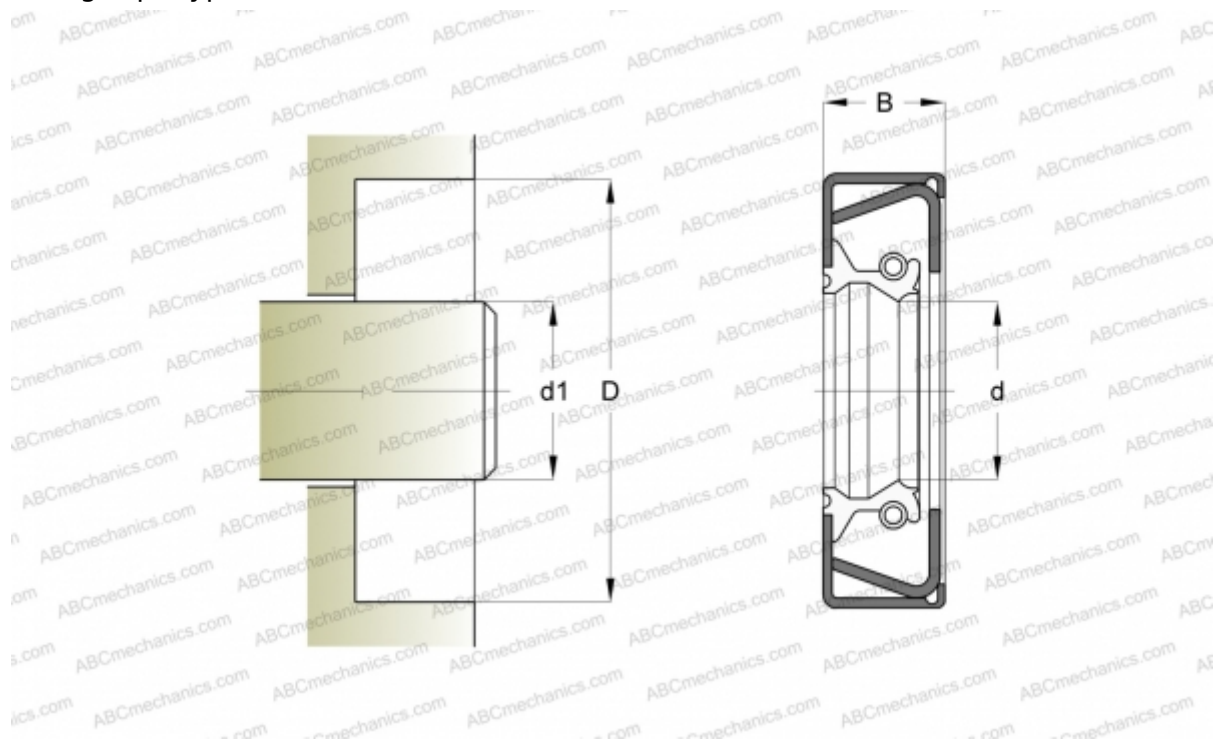

### Technical specification

#### DIMENSIONS, MM

d1	69,850
d	69,850
D	89,992
B	11,125

**MANUFACTURER** [SKF](#)

#### INTERCHANGE

CR	<a href="#">CR 27295</a>
----	--------------------------

#### CALCULATION DATA

Operating temperature min	-40 °C
Operating temperature max	150 °C
Permissible operating temperature, short periods max	175 °C
Pressure differential max	0,070 Mpa
Maximum shaft surface speed	18,000 m/s