

CR 32385 CR

Radial shaft seals

TYPE: Radial shaft seals, Metal case and a secondary reinforcement in the side face, With spring-loaded sealing slip, Type CRWHA1, material ACM (SKF)

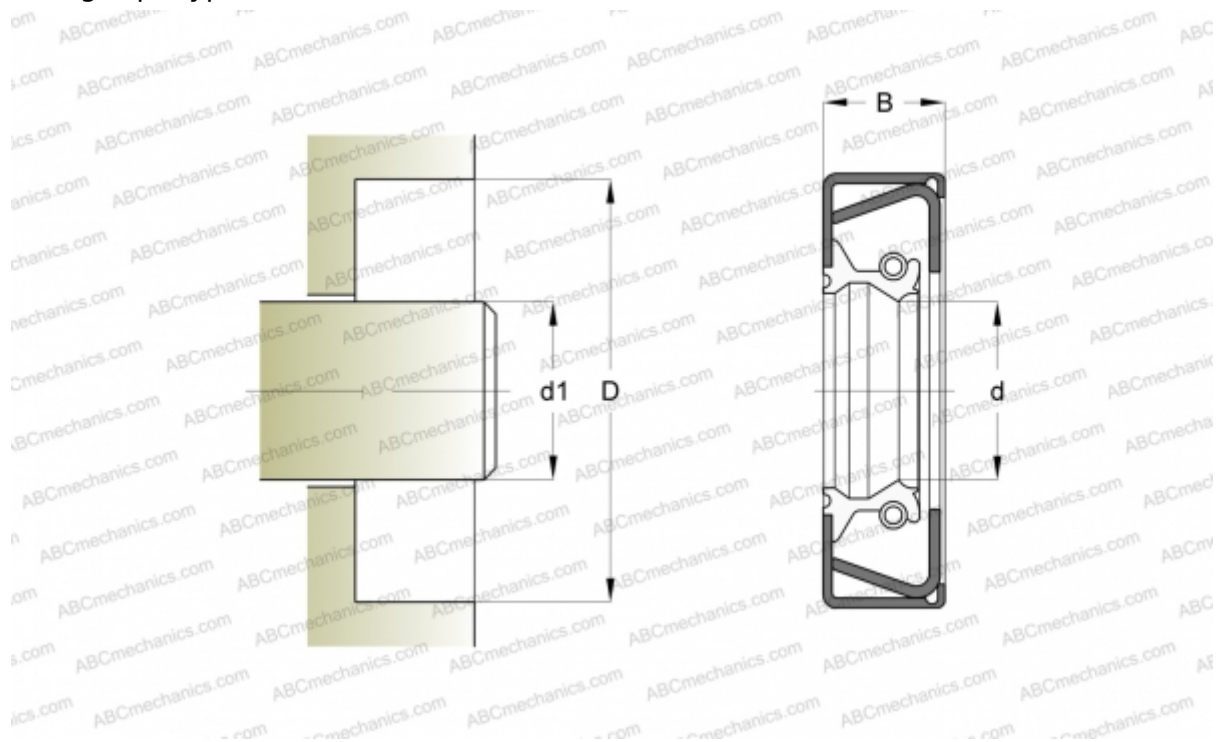

Technical specification

DIMENSIONS, MM

d1	82,550
d	82,550
D	107,925
B	11,125

MANUFACTURER [CR](#)

INTERCHANGE

SKF	32385
-----	-----------------------

CALCULATION DATA

Operating temperature min	-40 °C
Operating temperature max	150 °C
Permissible operating temperature, short periods max	175 °C
Pressure differential max	0,070 Mpa
Maximum shaft surface speed	18,000 m/s