

CR 21108 CR

Radial shaft seals

TYPE: Radial shaft seals, Metal case and a secondary reinforcement in the side face, With spring-loaded sealing slip, Type CRWHA1, material NBR (SKF)

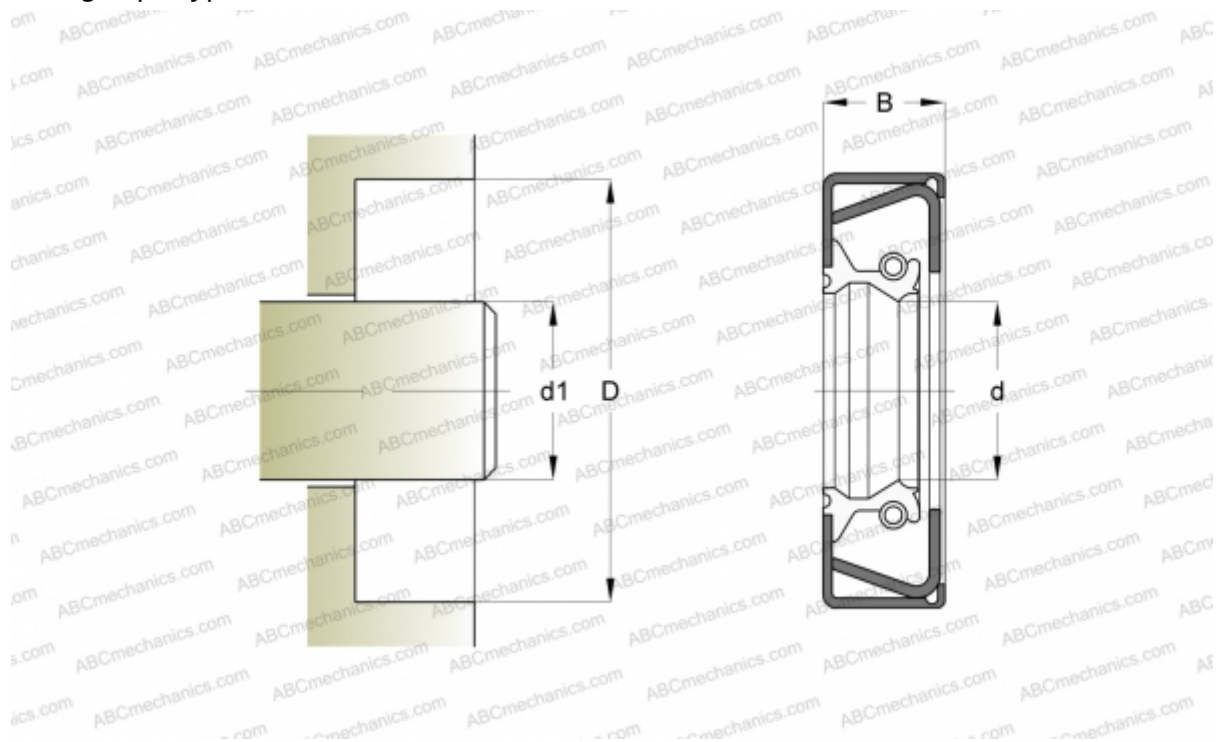

Technical specification

DIMENSIONS, MM

d1	53,975
d	53,975
D	73,025
B	11,125

MANUFACTURER [CR](#)

INTERCHANGE

SKF	21108
-----	-----------------------

CALCULATION DATA

Operating temperature min	-40 °C
Operating temperature max	100 °C
Permissible operating temperature, short periods max	120 °C
Pressure differential max	0,070 Mpa
Maximum shaft surface speed	18,000 m/s