

## CR 28746 CR

Radial shaft seals

TYPE: Radial shaft seals, Metal case and a secondary reinforcement in the side face, With spring-loaded sealing slip, Type CRWHA1, material NBR (SKF)

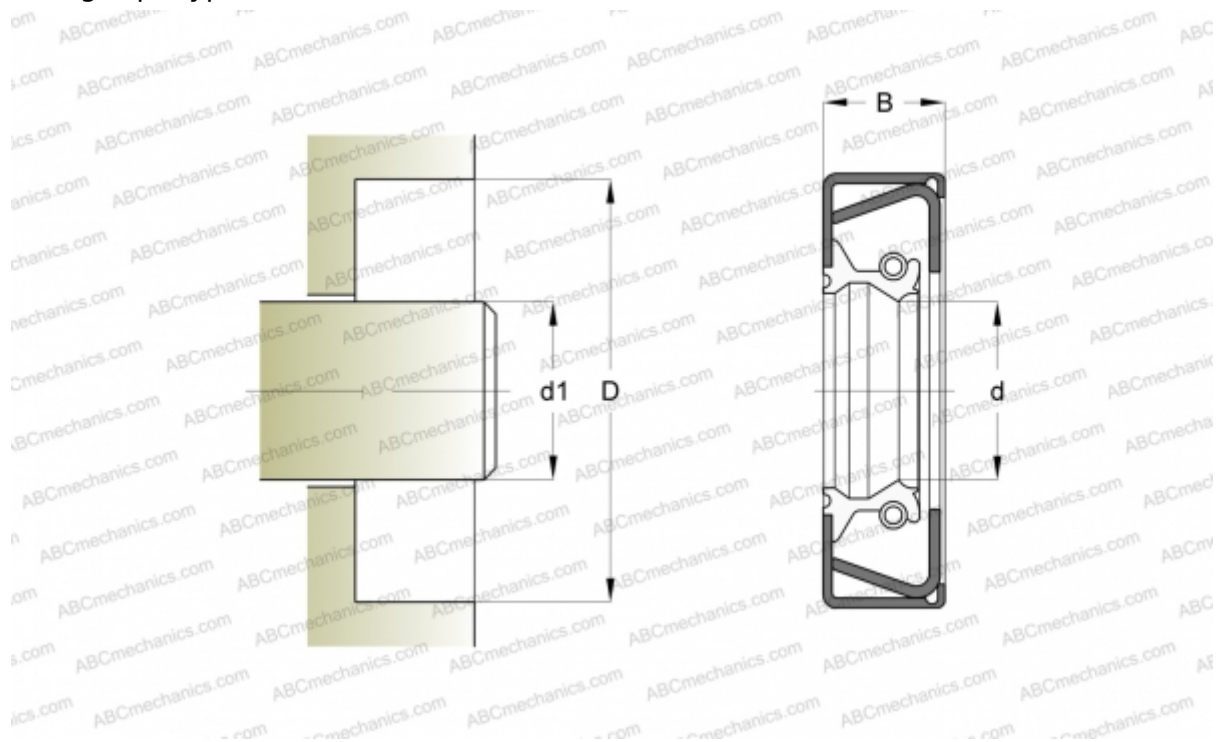

### Technical specification

#### DIMENSIONS, MM

d1	73,025
d	73,025
D	98,450
B	11,125

**MANUFACTURER** [CR](#)

#### INTERCHANGE

SKF	<a href="#">28746</a>
-----	-----------------------

#### CALCULATION DATA

Operating temperature min	-40 °C
Operating temperature max	100 °C
Permissible operating temperature, short periods max	120 °C
Pressure differential max	0,070 Mpa
Maximum shaft surface speed	18,000 m/s