

12533 SKF

Radial shaft seals

TYPE: Radial shaft seals, Metal case and a secondary reinforcement in the side face, With spring-loaded sealing slip, Type CRWHA1, material FPM/FKM (SKF)

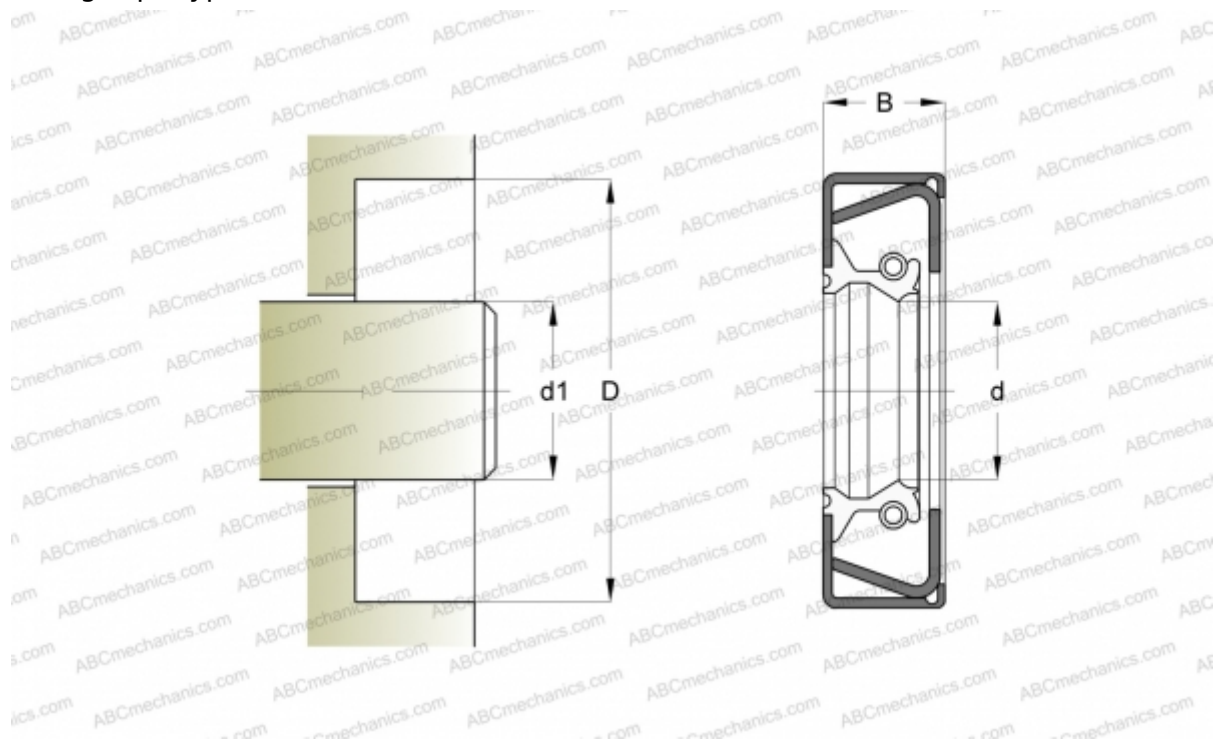

Technical specification

DIMENSIONS, MM

d1	31,750
d	31,750
D	52,375
B	10,998

MANUFACTURER [SKF](#)

INTERCHANGE

CR [CR 12533](#)

CALCULATION DATA

Operating temperature min	-40 °C
Operating temperature max	200 °C
Permissible operating temperature, short periods max	220 °C
Pressure differential max	0,070 Mpa
Maximum shaft surface speed	18,000 m/s