

## 31152 SKF

Radial shaft seals

TYPE: Radial shaft seals, Metal case and a secondary reinforcement in the side face, With spring-loaded sealing slip, Type CRWHA1, material FPM/FKM (SKF)

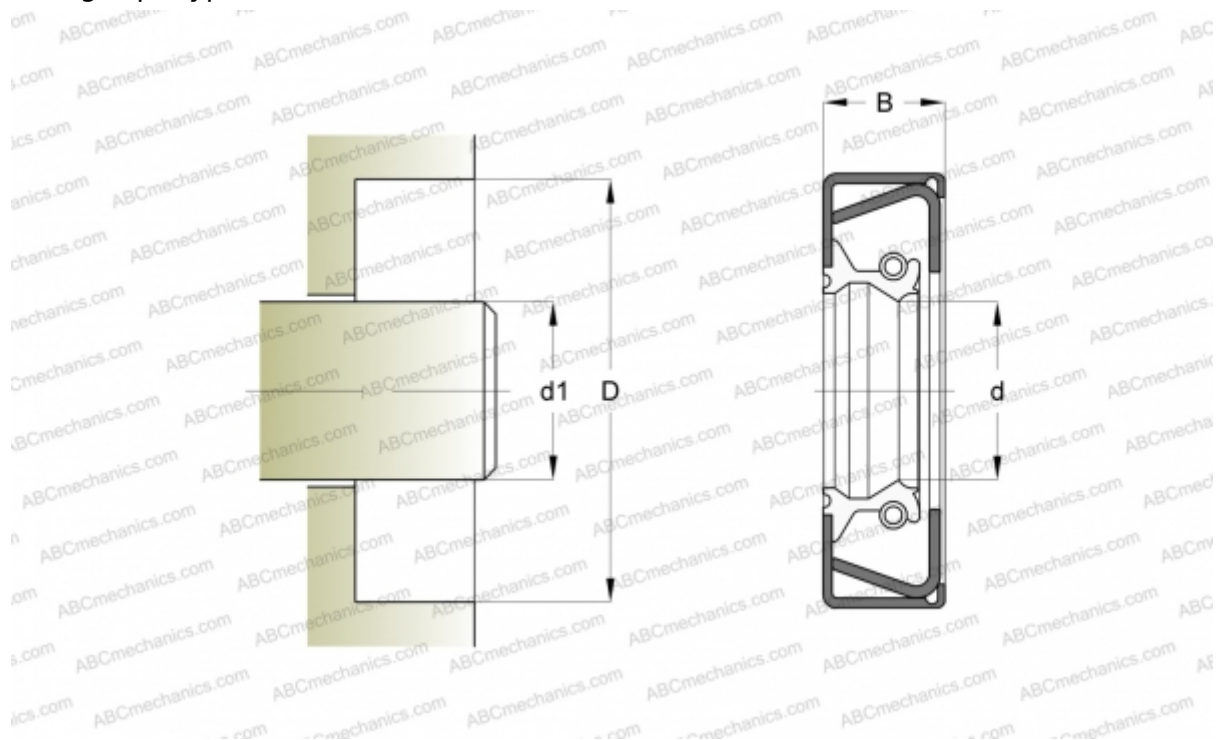

### Technical specification

#### DIMENSIONS, MM

d1	79,375
d	79,375
D	101,676
B	9,525

**MANUFACTURER** [SKF](#)

#### INTERCHANGE

CR [CR 31152](#)

#### CALCULATION DATA

Operating temperature min	-40 °C
Operating temperature max	200 °C
Permissible operating temperature, short periods max	220 °C
Pressure differential max	0,070 Mpa
Maximum shaft surface speed	18,000 m/s