

CR 31152 CR

Radial shaft seals

TYPE: Radial shaft seals, Metal case and a secondary reinforcement in the side face, With spring-loaded sealing slip, Type CRWHA1, material FPM/FKM (SKF)

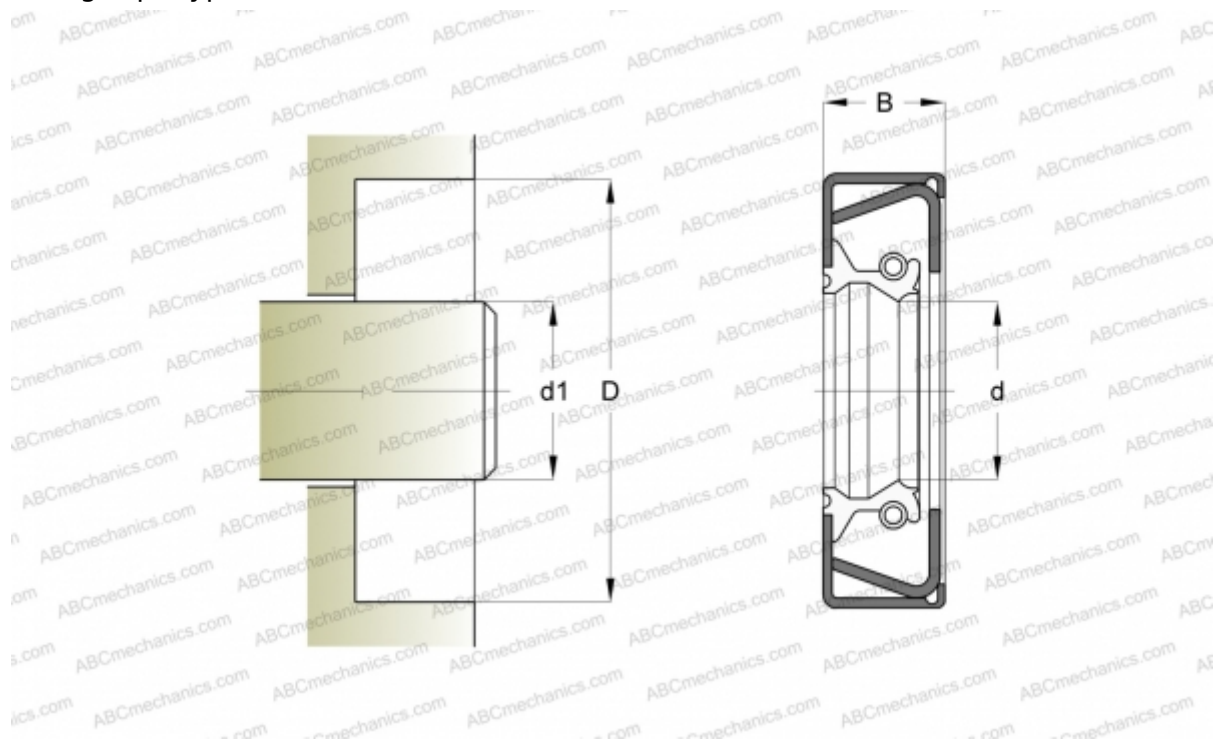

Technical specification

DIMENSIONS, MM

d_1	79,375
d	79,375
D	101,676
B	9,525

MANUFACTURER [CR](#)

INTERCHANGE

SKF	31152
-----	-----------------------

CALCULATION DATA

Operating temperature min	-40 °C
Operating temperature max	200 °C
Permissible operating temperature, short periods max	220 °C
Pressure differential max	0,070 Mpa
Maximum shaft surface speed	18,000 m/s