

14035 SKF

Radial shaft seals

TYPE: Radial shaft seals, Metal case and a secondary reinforcement in the side face, With spring-loaded sealing lip, Type CRSHA1, material NBR (SKF)

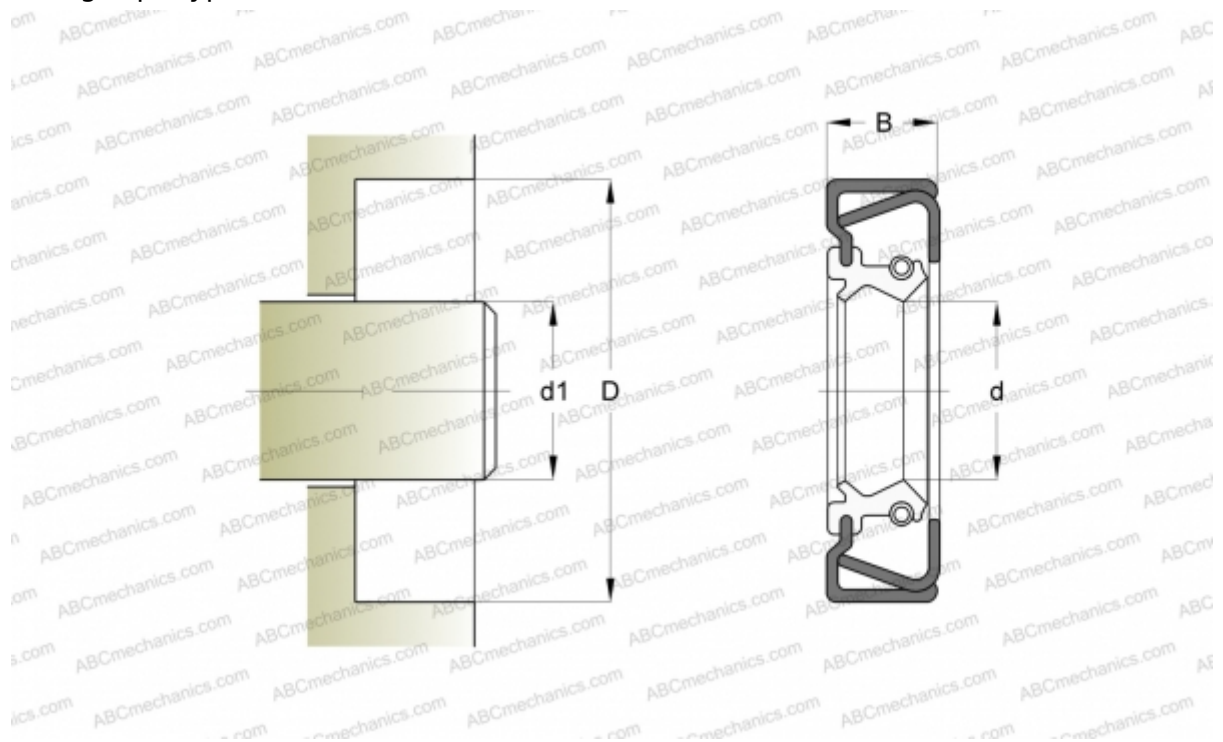

Technical specification

DIMENSIONS, MM

d1	35,916
d	35,916
D	57,150
B	6,350

MANUFACTURER [SKF](#)

INTERCHANGE

CR [CR 14035](#)

CALCULATION DATA

Operating temperature min	-40 °C
Operating temperature max	100 °C
Permissible operating temperature, short periods max	120 °C
Pressure differential max	0,070 Mpa
Maximum shaft surface speed	10,000 m/s