

CR 50185 CR

Radial shaft seals

TYPE: Radial shaft seals, Metal case and a secondary reinforcement in the side face, With spring-loaded sealing slip, Type CRSHA1, material NBR (SKF)

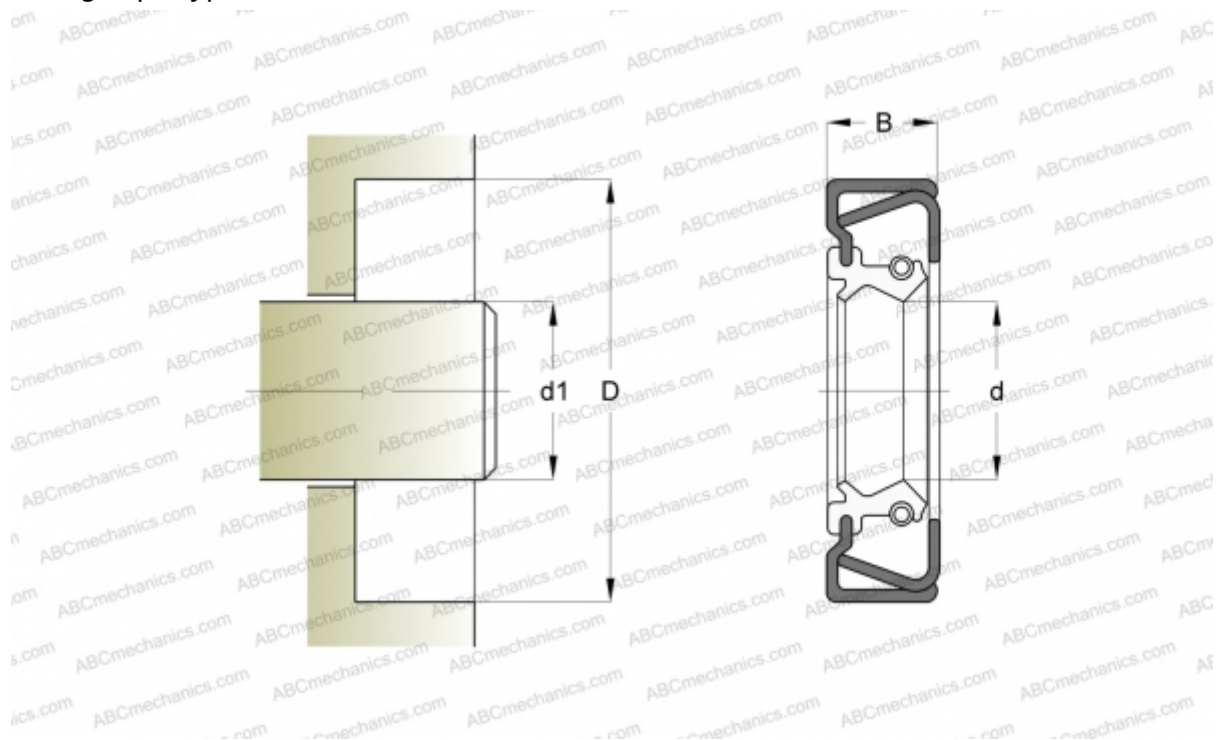

Technical specification

DIMENSIONS, MM

d1	127,000
d	127,000
D	177,800
B	12,700

MANUFACTURER [CR](#)

INTERCHANGE

SKF	50185
-----	-----------------------

CALCULATION DATA

Operating temperature min	-40 °C
Operating temperature max	100 °C
Permissible operating temperature, short periods max	120 °C
Pressure differential max	0,070 Mpa
Maximum shaft surface speed	10,000 m/s