

## 57578 SKF

Radial shaft seals

TYPE: Radial shaft seals, Metal case and a secondary reinforcement in the side face, With spring-loaded sealing lip, Type CRSHA1, material NBR (SKF)

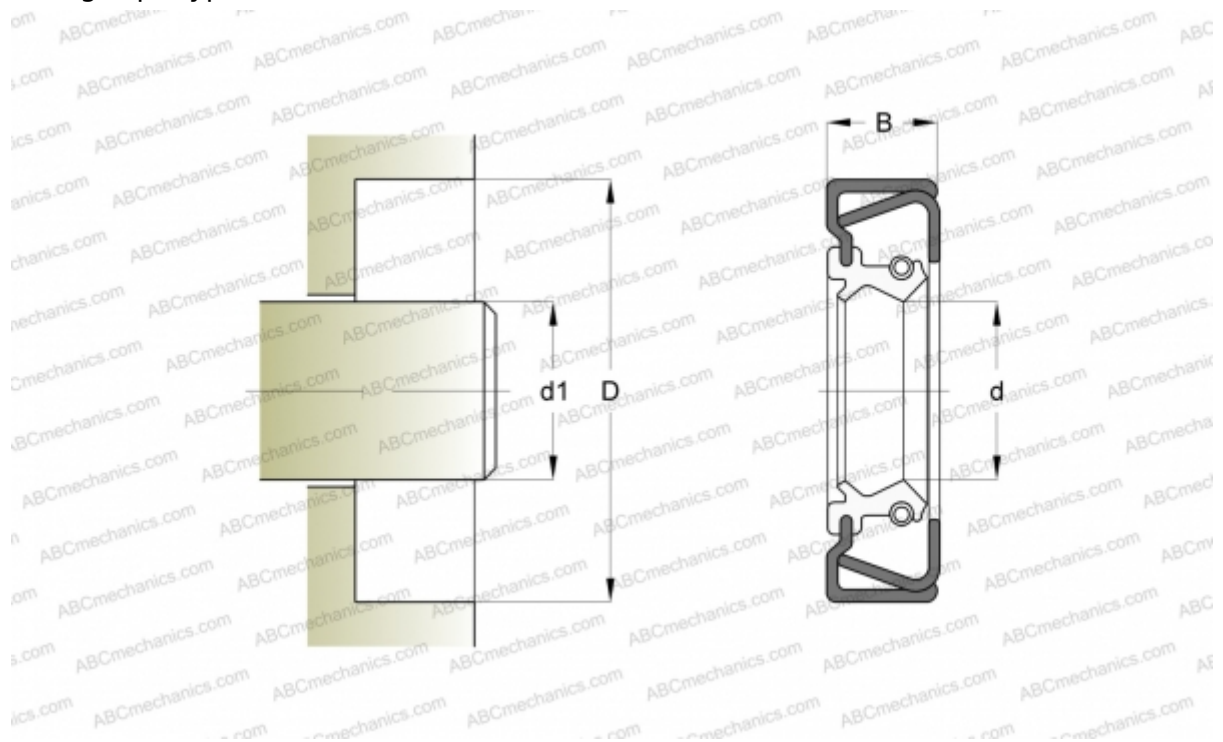

### Technical specification

#### DIMENSIONS, MM

d1	146,050
d	146,050
D	181,000
B	14,300

**MANUFACTURER** [SKF](#)

#### INTERCHANGE

CR [CR 57578](#)

#### CALCULATION DATA

Operating temperature min	-40 °C
Operating temperature max	100 °C
Permissible operating temperature, short periods max	120 °C
Pressure differential max	0,070 Mpa
Maximum shaft surface speed	10,000 m/s