

210x240x15 HMSA10 V SKF

Radial shaft seals

TYPE: Radial shaft seals, With a rubber outside diameter, With spring-loaded sealing lip, Type HMSA10, material FPM/FKM (SKF)

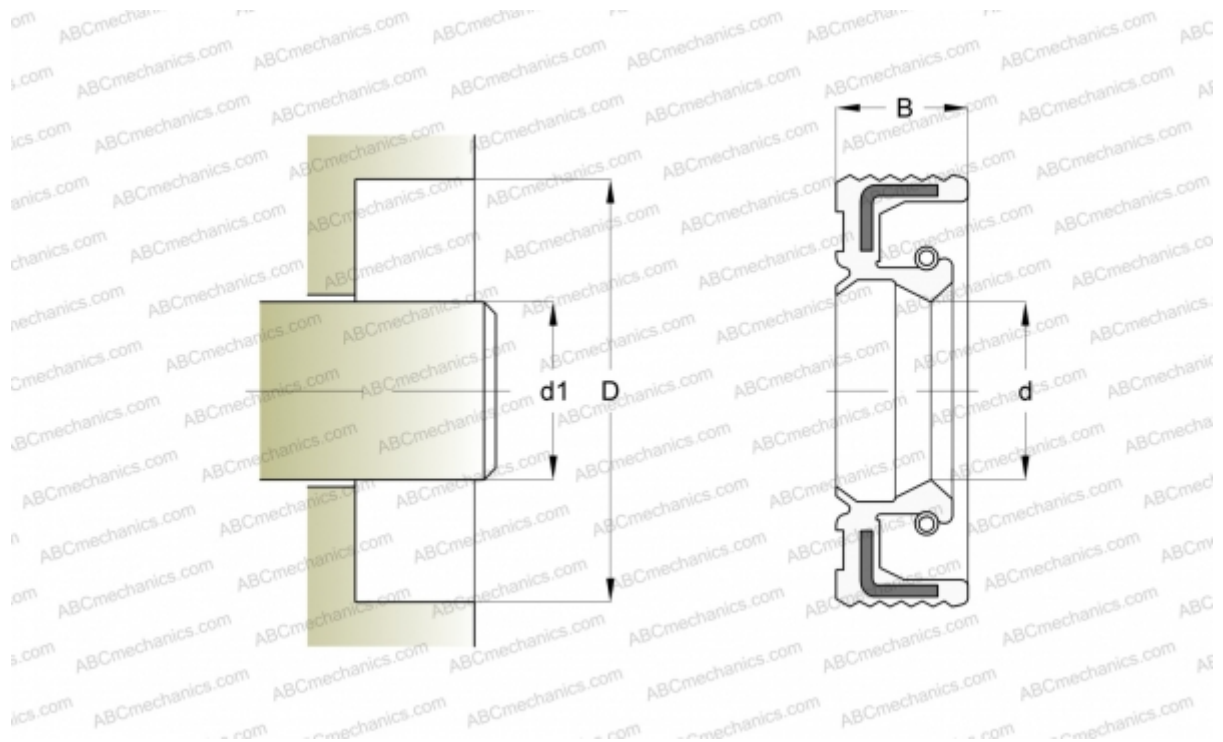

Technical specification

DIMENSIONS, MM

d1	210,000
d	210,000
D	240,000
B	15,000

MANUFACTURER [SKF](#)

CALCULATION DATA

Operating temperature min	-20 °C
Operating temperature max	200 °C
Permissible operating temperature, short periods max	200 °C
Pressure differential max	0,030 Mpa
Maximum shaft surface speed	0,001 m/s