

240x270x15 HMSA10 RG SKF

Radial shaft seals

TYPE: Radial shaft seals, With a rubber outside diameter, With spring-loaded sealing lip, Type HMSA10, material NBR (SKF)

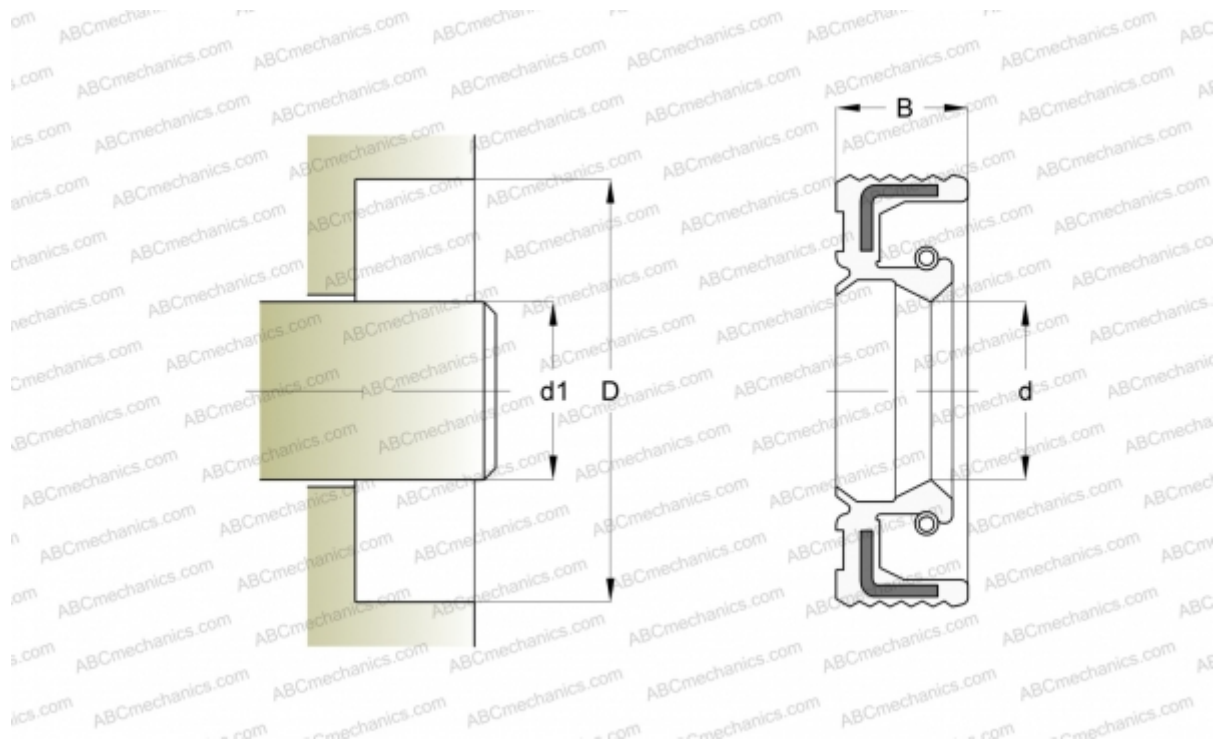

Technical specification

DIMENSIONS, MM

d_1	240,000
d	240,000
D	270,000
B	15,000

MANUFACTURER [SKF](#)

CALCULATION DATA

Operating temperature min	-40 °C
Operating temperature max	100 °C
Permissible operating temperature, short periods max	120 °C
Pressure differential max	0,030 Mpa
Maximum shaft surface speed	0,001 m/s