

535x580x20 HDS3 D SKF

Radial shaft seals

TYPE: Seals for heavy industrial applications, Metal case, With spring-loaded sealing lip, Type HDS3, material X-NBR (SKF)

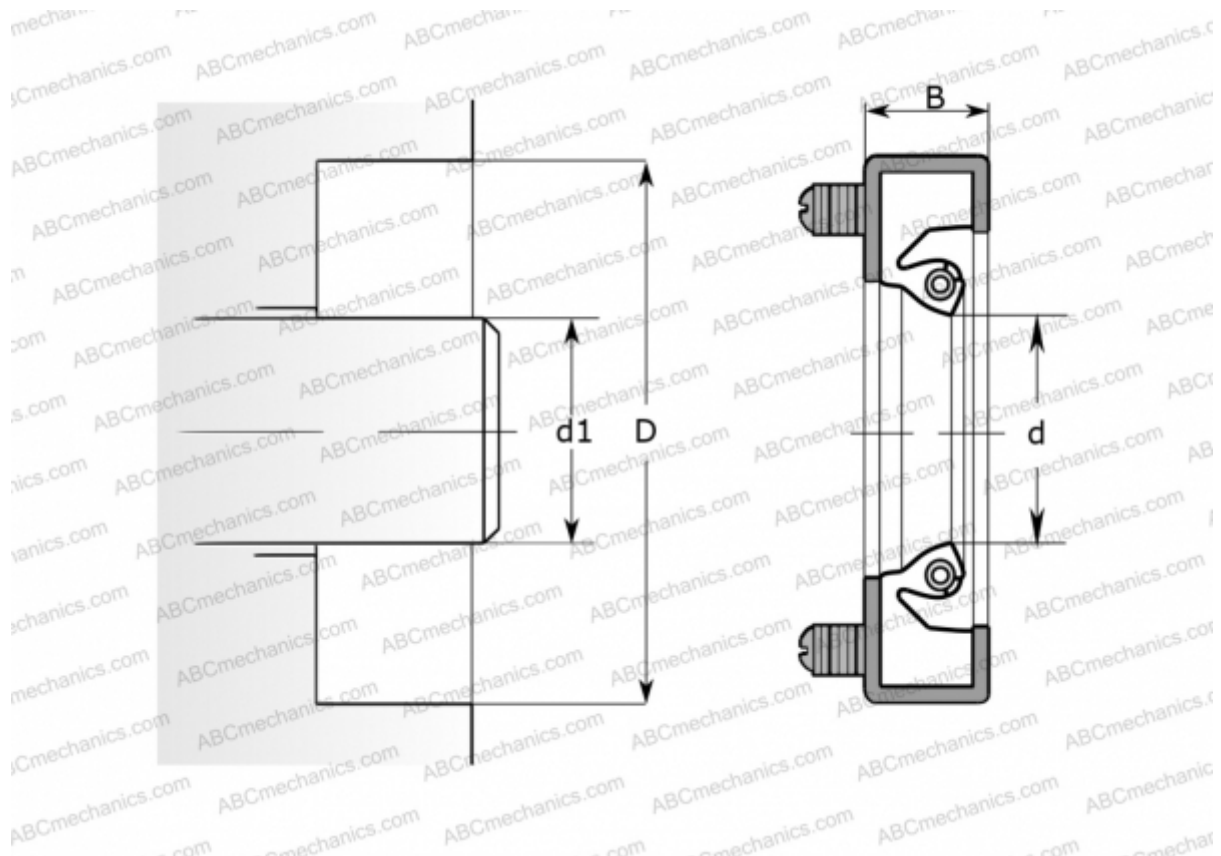

Technical specification

DIMENSIONS, MM

d1	535,000
d	535,000
D	580,000
B	20,000

MANUFACTURER [SKF](#)

CALCULATION DATA

Operating temperature min	-55 °C
Operating temperature max	105 °C
Permissible operating temperature, short periods max	125 °C
Pressure differential max	0,100 Mpa
Maximum shaft surface speed	25,000 m/s