

## 670x714x20 HDS3 D SKF

Radial shaft seals

TYPE: Seals for heavy industrial applications, Metal case, With spring-loaded sealing lip, Type HDS3, material X-NBR (SKF)

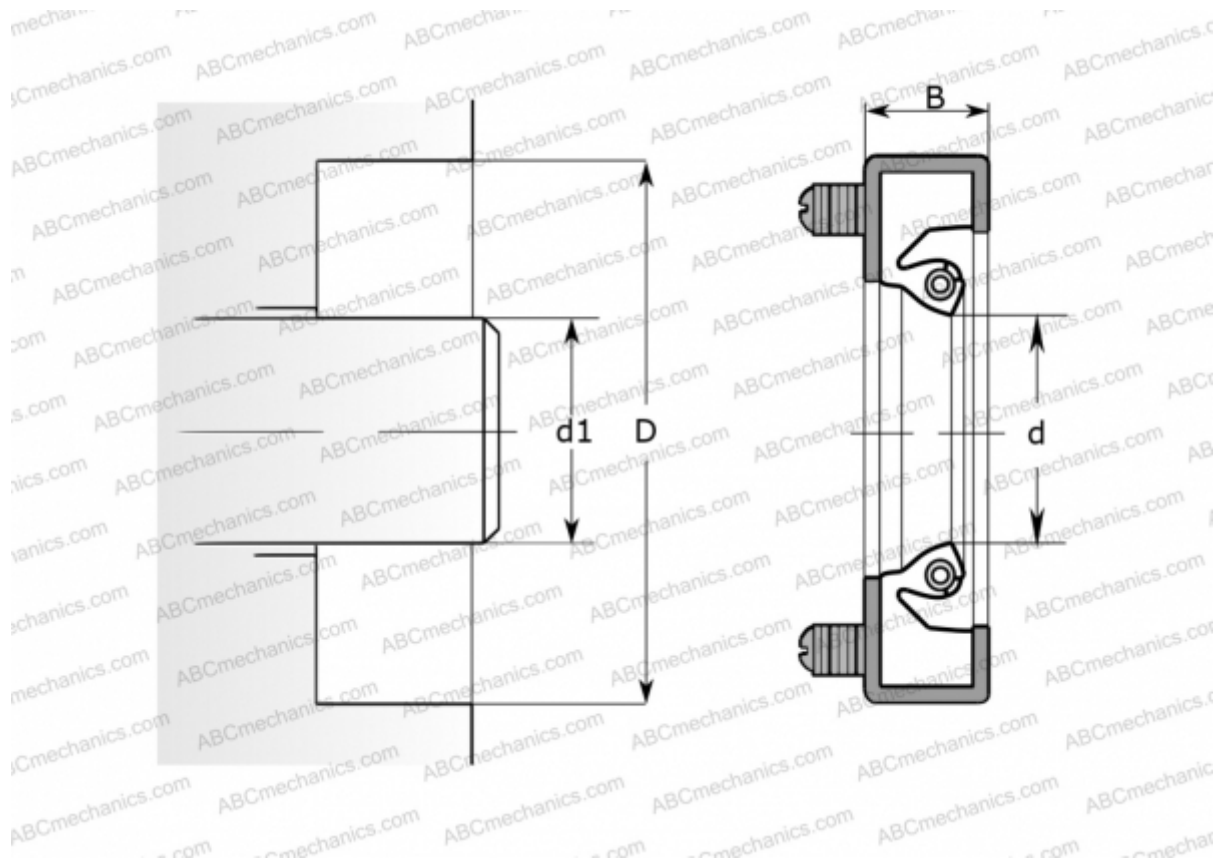

### Technical specification

#### DIMENSIONS, MM

$d_1$	670,000
$d$	670,000
$D$	714,000
$B$	20,000

#### MANUFACTURER

[SKF](#)

#### CALCULATION DATA

Operating temperature min	-55 °C
Operating temperature max	105 °C
Permissible operating temperature, short periods max	125 °C
Pressure differential max	0,100 Mpa
Maximum shaft surface speed	25,000 m/s