

1200239 SKF

Radial shaft seals

TYPE: Seals for heavy industrial applications, Metal case, With spring-loaded sealing lip, Type HDS3, material X-NBR (SKF)

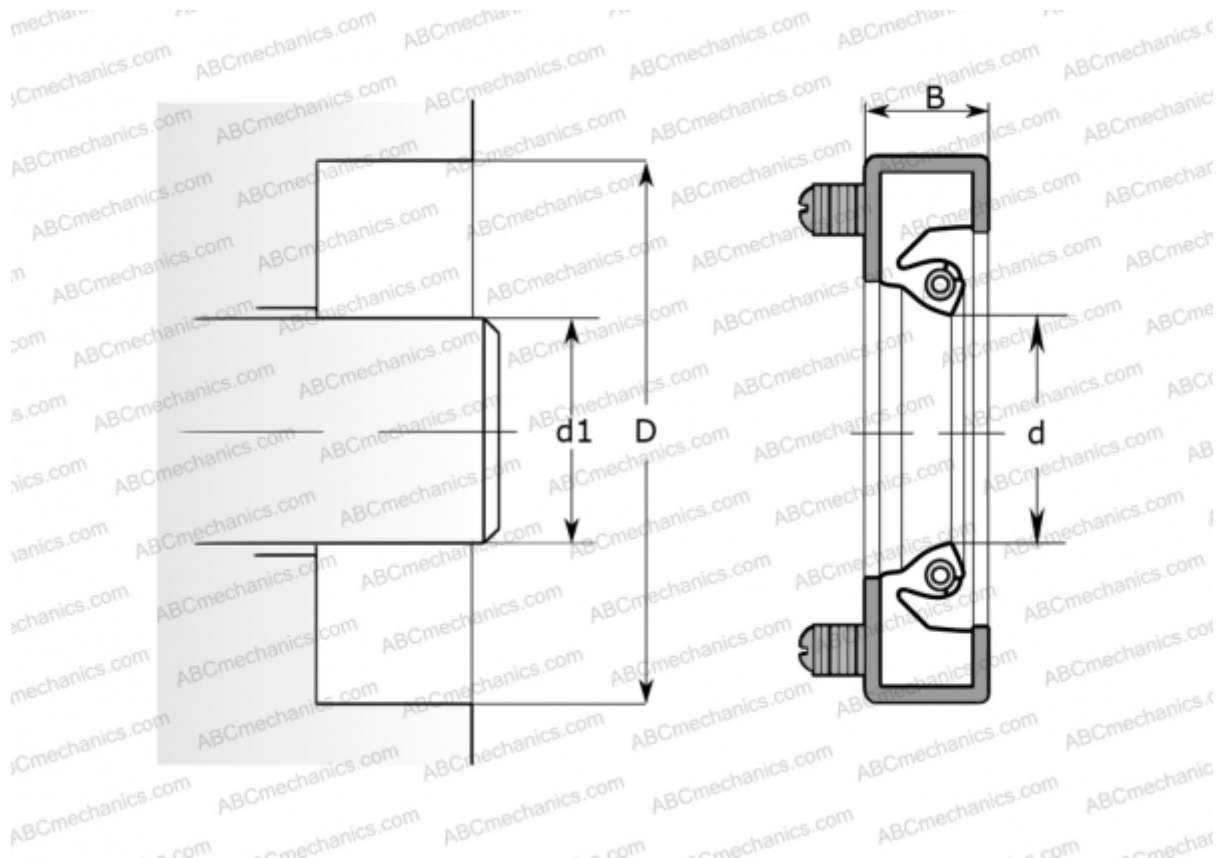

Technical specification

DIMENSIONS, MM

d1	304,800
d	304,800
D	342,900
B	15,880

MANUFACTURER

[SKF](#)

CALCULATION DATA

Operating temperature min	-55 °C
Operating temperature max	105 °C
Permissible operating temperature, short periods max	125 °C
Pressure differential max	0,100 Mpa
Maximum shaft surface speed	25,000 m/s