

## 1575249 SKF

Radial shaft seals

TYPE: Seals for heavy industrial applications, Metal case, With spring-loaded sealing lip, Type HDS3, material X-NBR (SKF)

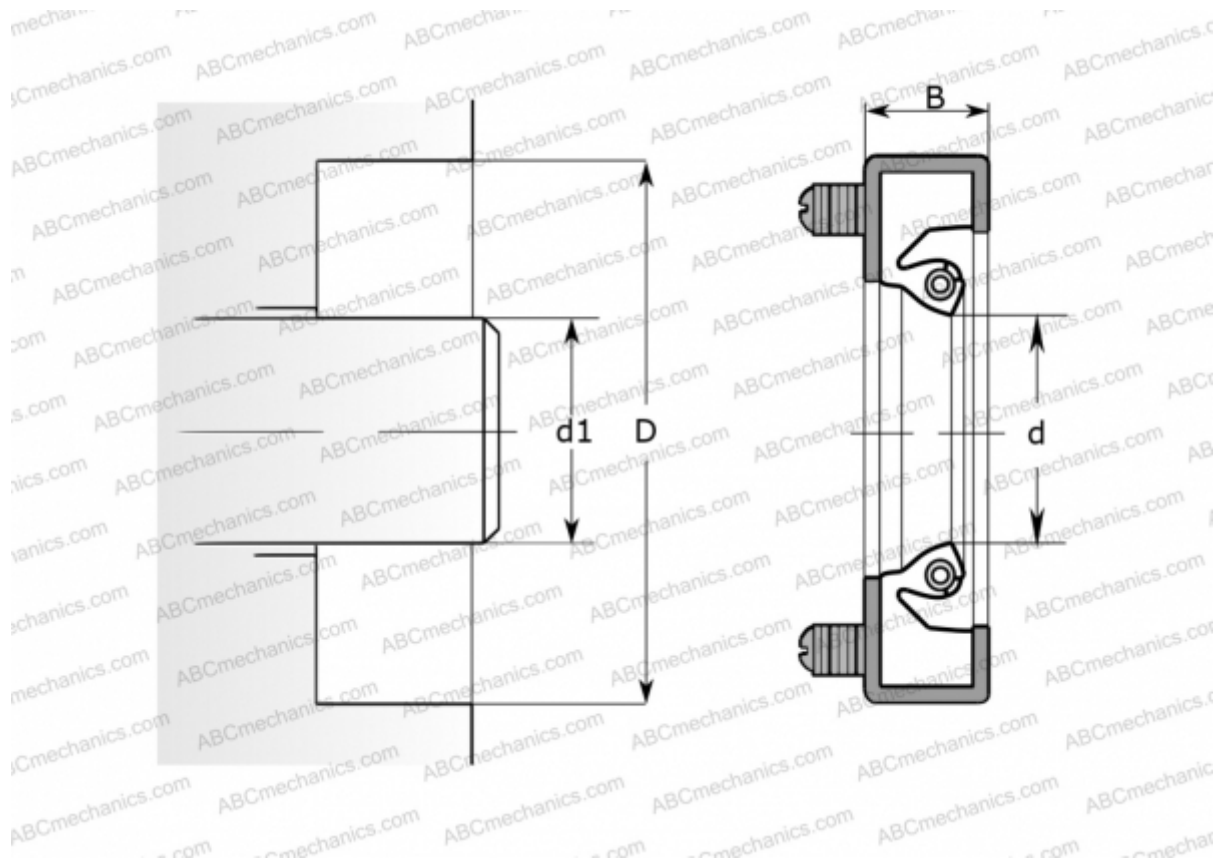

### Technical specification

#### DIMENSIONS, MM

d1	400,050
d	400,050
D	438,150
B	17,480

#### MANUFACTURER

[SKF](#)

#### CALCULATION DATA

Operating temperature min	-55 °C
Operating temperature max	105 °C
Permissible operating temperature, short periods max	125 °C
Pressure differential max	0,100 Mpa
Maximum shaft surface speed	25,000 m/s