

## 400x450x18 HDS7K R SKF

Radial shaft seals

TYPE: Seals for heavy industrial applications, With a rubber outside diameter, With spring-loaded sealing lip, Type HDS7K, material NBR (SKF)

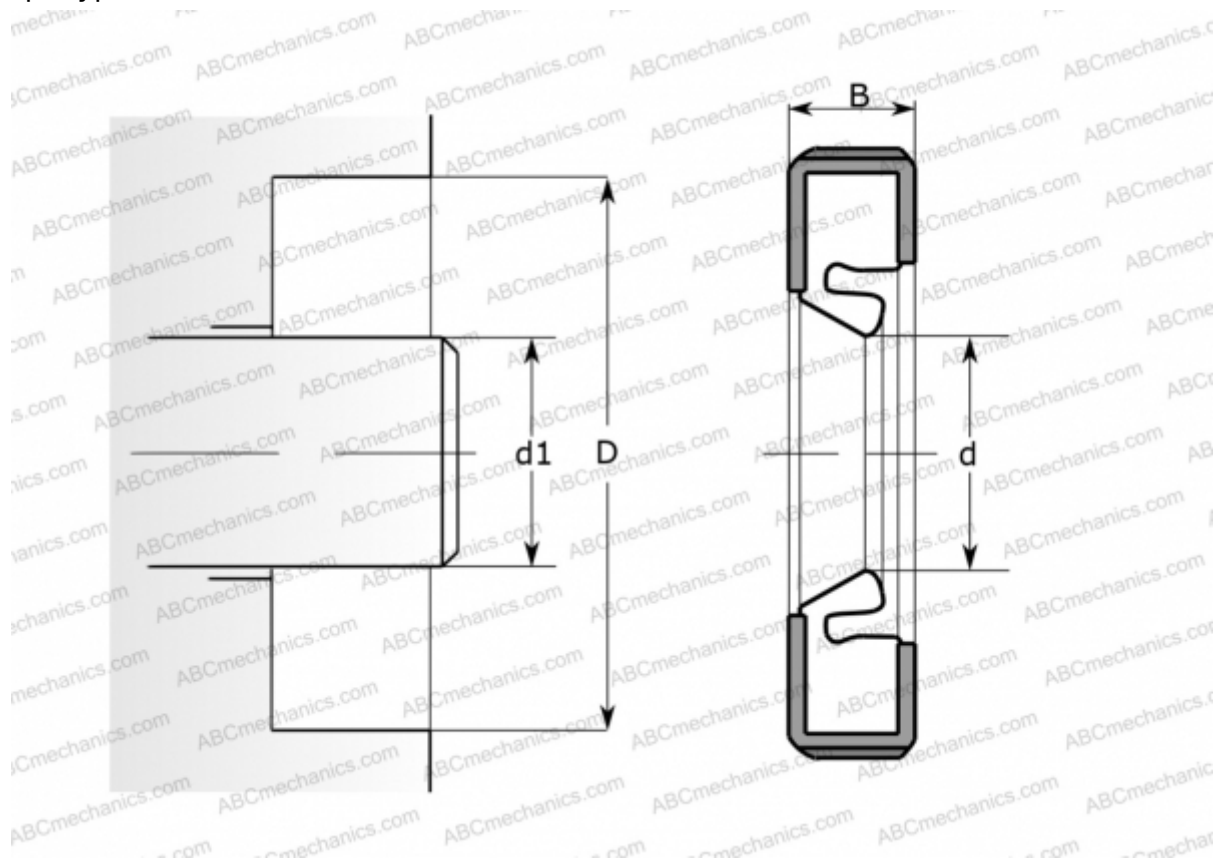

### Technical specification

#### DIMENSIONS, MM

$d_1$	400,000
$d$	400,000
$D$	450,000
$B$	18,000

#### MANUFACTURER

[SKF](#)

#### INTERCHANGE

CR [CR 400x450x18 HDS7K R](#)

#### CALCULATION DATA

Operating temperature min	-40 °C
Operating temperature max	120 °C
Permissible operating temperature, short periods max	140 °C
Pressure differential max	0,100 Mpa
Maximum shaft surface speed	25,000 m/s