

450x500x18 HDS7K R SKF

Radial shaft seals

TYPE: Seals for heavy industrial applications, With a rubber outside diameter, With spring-loaded sealing slip, Type HDS7K, material NBR (SKF)

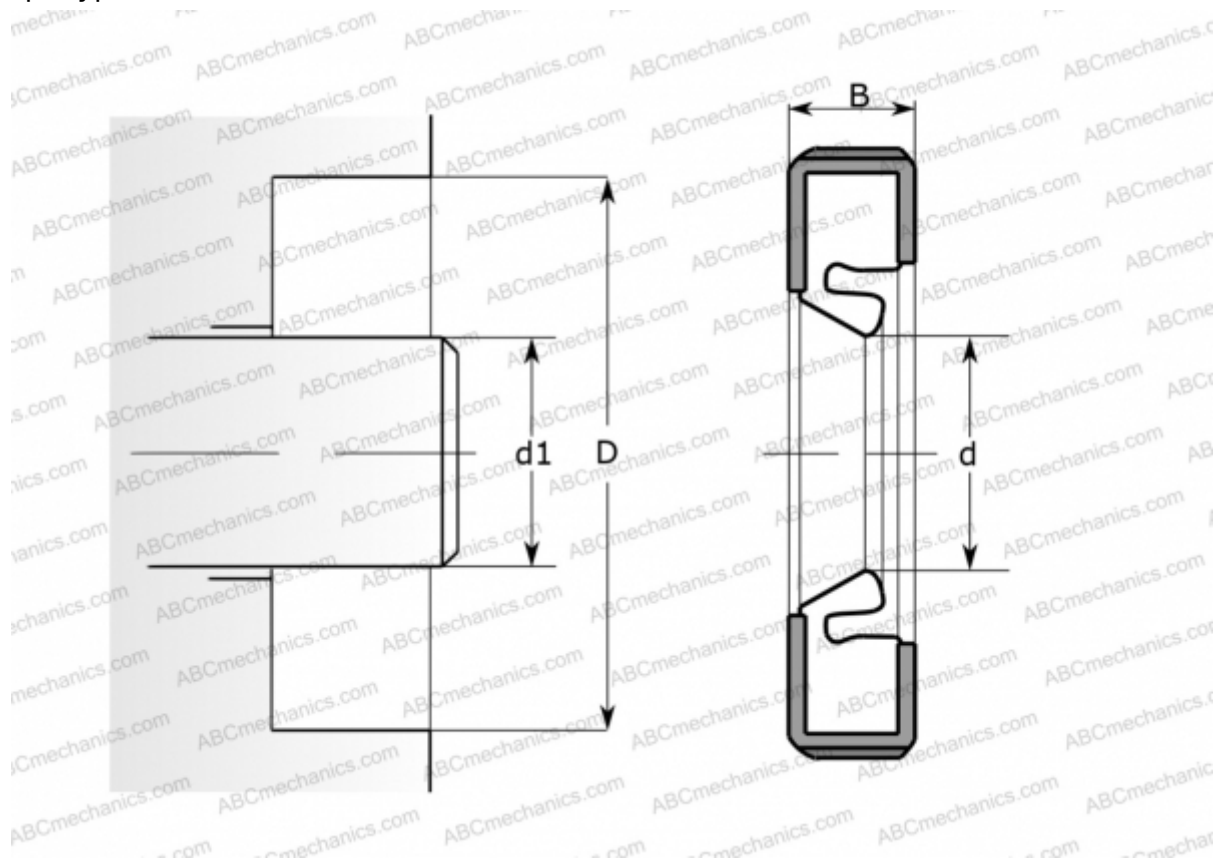

Technical specification

DIMENSIONS, MM

d_1	450,000
d	450,000
D	500,000
B	18,000

MANUFACTURER

[SKF](#)

INTERCHANGE

CR [CR 450x500x18 HDS7K R](#)

CALCULATION DATA

Operating temperature min	-40 °C
Operating temperature max	120 °C
Permissible operating temperature, short periods max	140 °C
Pressure differential max	0,100 Mpa
Maximum shaft surface speed	25,000 m/s