

260x290x16 SBF R SKF

Radial shaft seals

TYPE: Seals for heavy industrial applications, Metal-inserted seals, With spring-loaded sealing lip, Type SBF, material NBR (SKF)

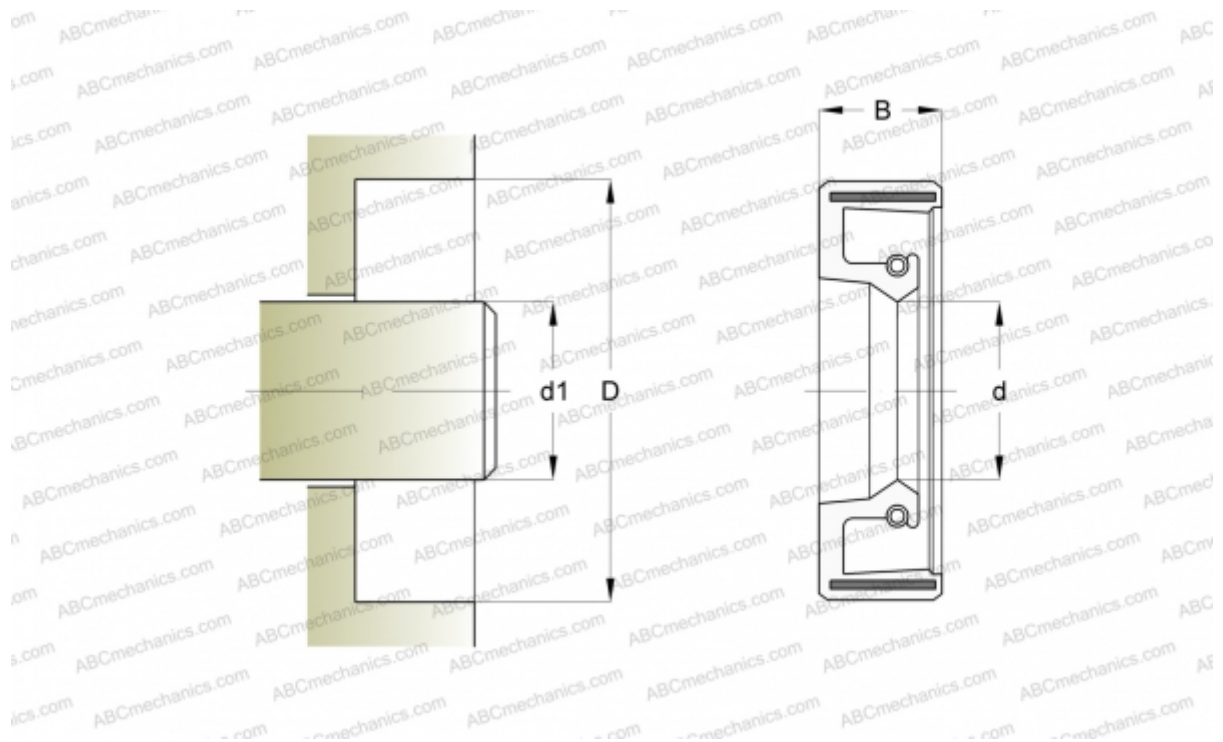

Technical specification

DIMENSIONS, MM

d_1	260,000
d	260,000
D	290,000
B	16,000

MANUFACTURER [SKF](#)

CALCULATION DATA

Operating temperature min	-40 °C
Operating temperature max	121 °C
Pressure differential max	0,100 Mpa
Maximum shaft surface speed	25,000 m/s