

360x400x20 SBF V SKF

Radial shaft seals

TYPE: Seals for heavy industrial applications, Metal-inserted seals, With spring-loaded sealing lip, Type SBF, material FPM/FKM (SKF)

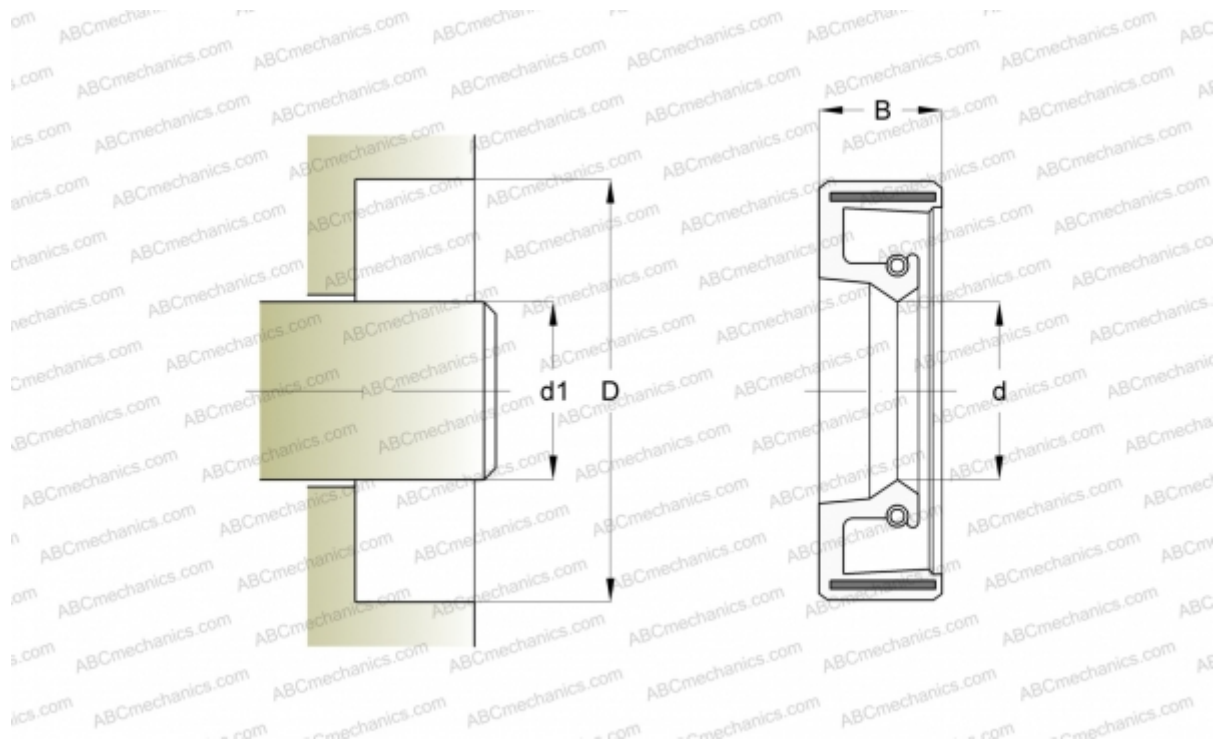

Technical specification

DIMENSIONS, MM

d1	360,000
d	360,000
D	400,000
B	20,000

MANUFACTURER [SKF](#)

CALCULATION DATA

Operating temperature min	-40 °C
Operating temperature max	204 °C
Pressure differential max	0,100 Mpa
Maximum shaft surface speed	25,000 m/s