

SBF 7083 V SKF

Radial shaft seals

TYPE: Seals for heavy industrial applications, Metal-inserted seals, With spring-loaded sealing lip, Type SBF, material FPM/FKM (SKF)

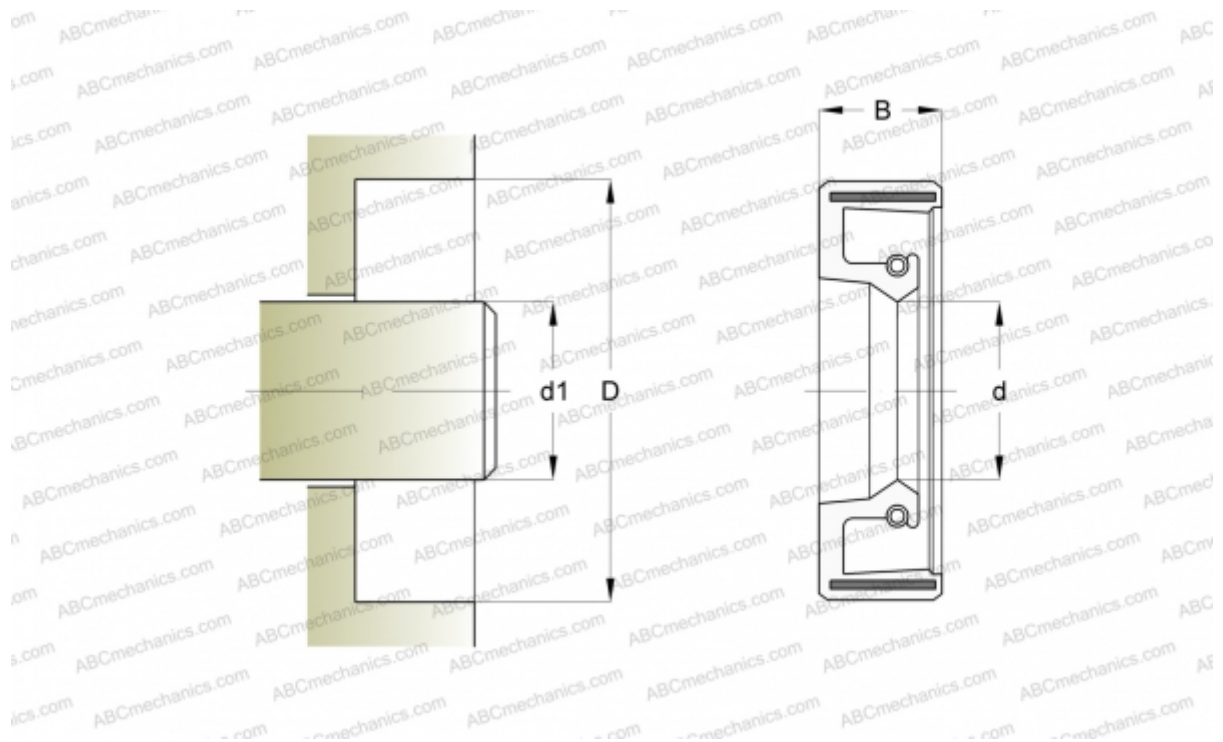

Technical specification

DIMENSIONS, MM

d_1	520,700
d	520,700
D	571,500
B	22,230

MANUFACTURER [SKF](#)

CALCULATION DATA

Operating temperature min	-40 °C
Operating temperature max	204 °C
Pressure differential max	0,100 Mpa
Maximum shaft surface speed	25,000 m/s