

32 VA V SKF

Axial shaft seals

TYPE: Axial shaft seals, V-ring seals, All-rubber seals, Type VA/VR1, material FPM/FKM (SKF)

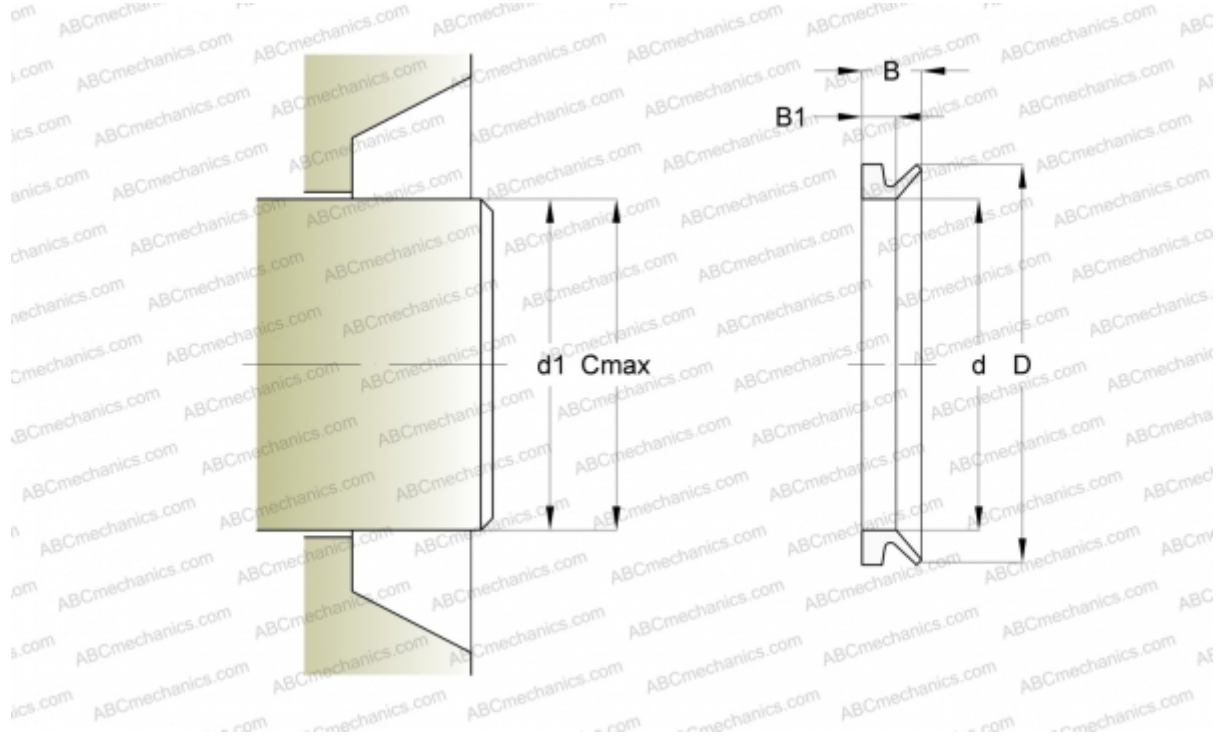

Technical specification

DIMENSIONS, MM

d1	31,000
d	29,000
D	37,000
B	7,500
B1	4,700
C	33,000

MANUFACTURER

[SKF](#)

CALCULATION DATA

Operating temperature min	-20 °C
Operating temperature max	150 °C
Permissible operating temperature, short periods max	170 °C
Maximum shaft surface speed	0,001 m/s