

8 VS R SKF

Axial shaft seals

TYPE: Axial shaft seals, V-ring seals, All-rubber seals, Type VS/VR2, material NBR (SKF)

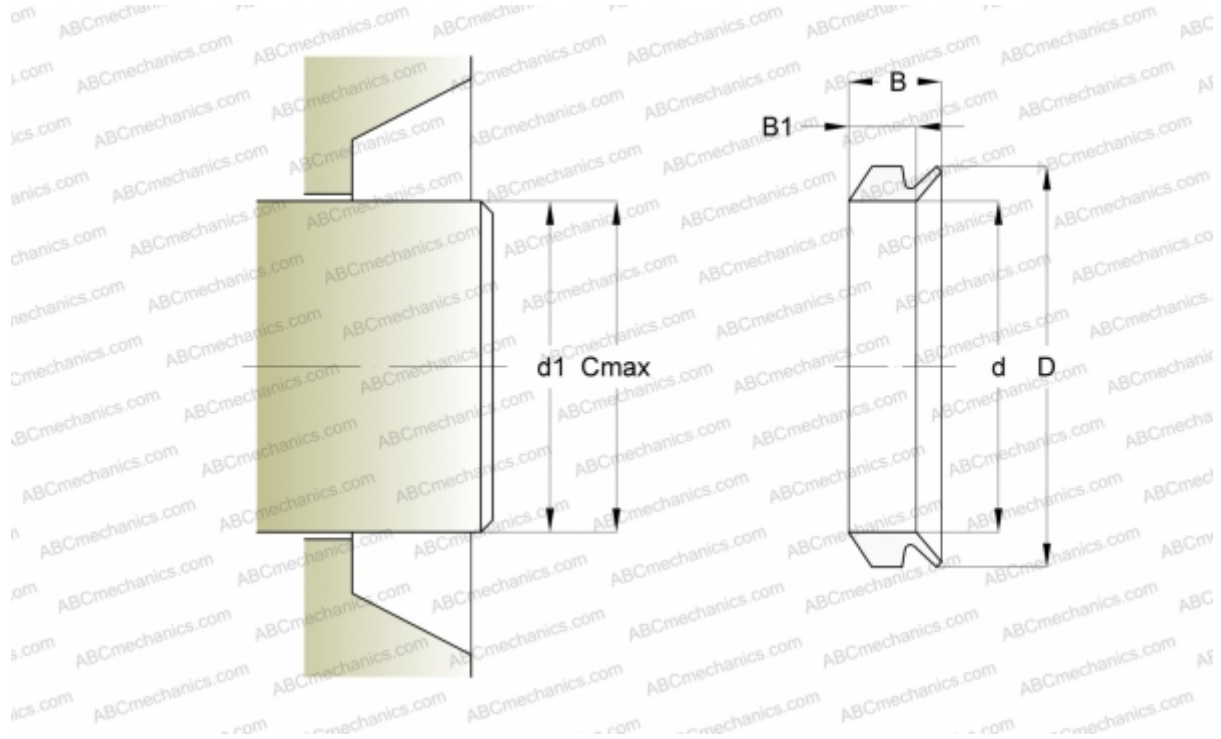

Technical specification

DIMENSIONS, MM

d1	8,000
d	7,000
D	11,000
B	5,200
B1	3,900
C	9,500

MANUFACTURER [SKF](#)

CALCULATION DATA

Operating temperature min	-40 °C
Operating temperature max	100 °C
Permissible operating temperature, short periods max	120 °C