

14 VS R SKF

Axial shaft seals

TYPE: Axial shaft seals, V-ring seals, All-rubber seals, Type VS/VR2, material NBR (SKF)

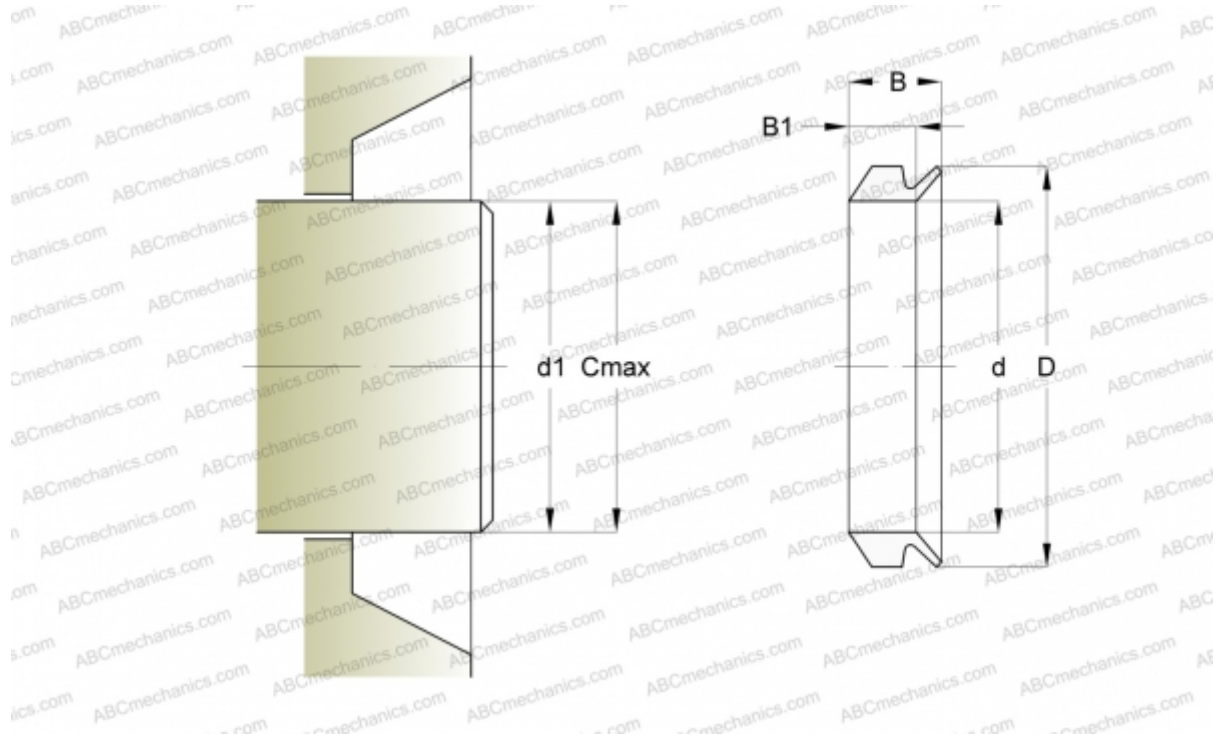

Technical specification

DIMENSIONS, MM

d_1	13,500
d	12,500
D	18,500
B	7,700
B_1	5,600
C	15,500

MANUFACTURER

[SKF](#)

CALCULATION DATA

Operating temperature min	-40 °C
Operating temperature max	100 °C
Permissible operating temperature, short periods max	120 °C
Maximum shaft surface speed	0,001 m/s