

## 35 VS R SKF

Axial shaft seals

TYPE: Axial shaft seals, V-ring seals, All-rubber seals, Type VS/VR2, material NBR (SKF)

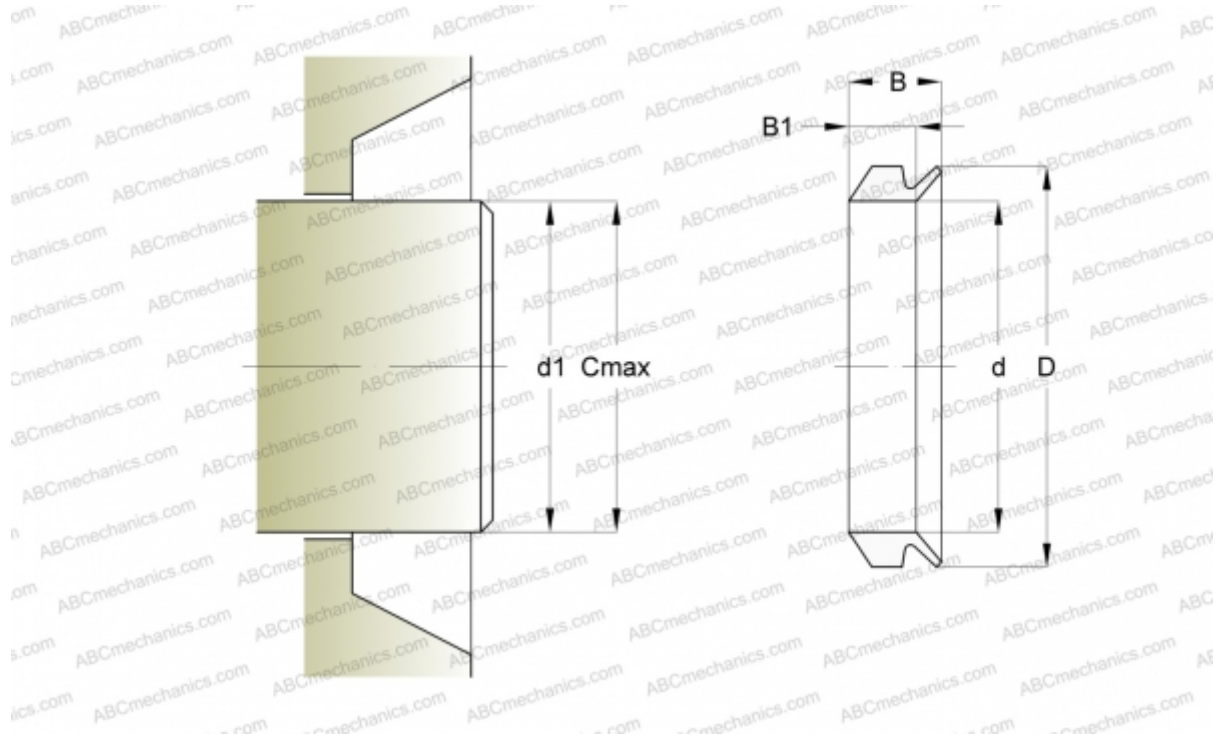

### Technical specification

#### DIMENSIONS, MM

d1	33,000
d	31,000
D	39,000
B	10,500
B1	7,900
C	36,000

#### MANUFACTURER

[SKF](#)

#### CALCULATION DATA

Operating temperature min	-40 °C
Operating temperature max	100 °C
Permissible operating temperature, short periods max	120 °C
Maximum shaft surface speed	0,001 m/s