

18 VS V SKF

Axial shaft seals

TYPE: Axial shaft seals, V-ring seals, All-rubber seals, Type VS/VR2, material FPM/FKM (SKF)

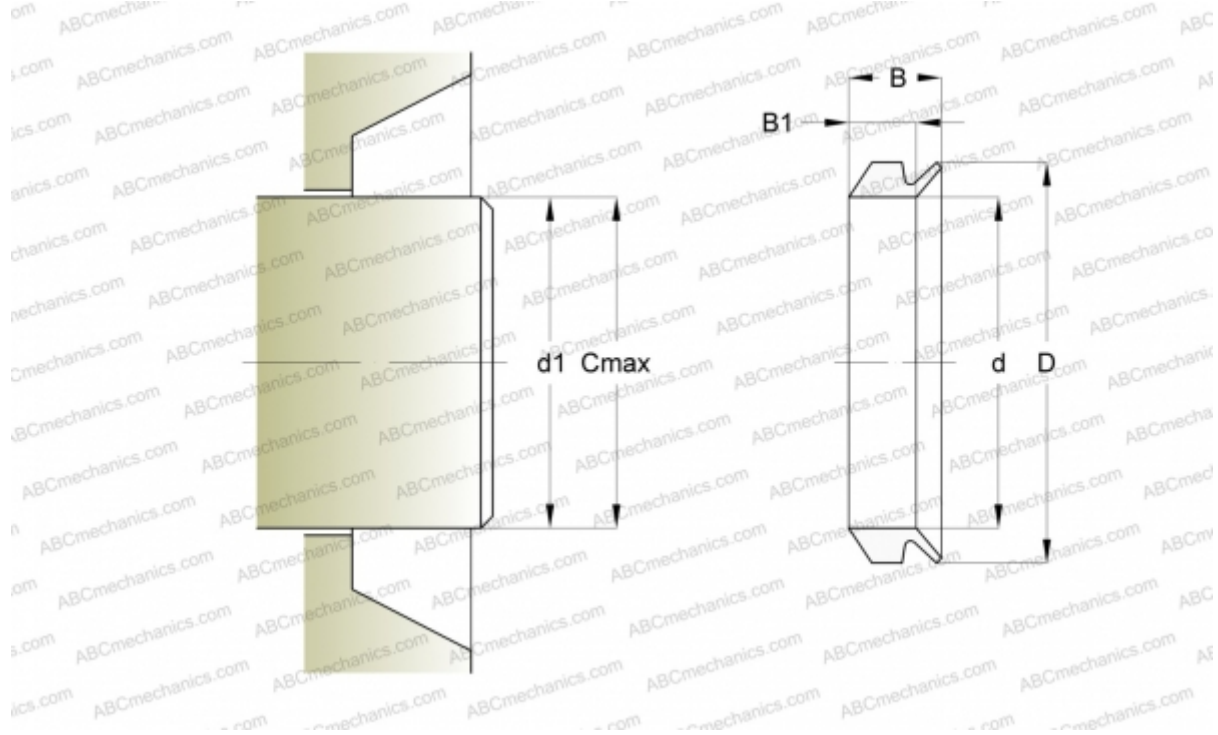

Technical specification

DIMENSIONS, MM

d1	17,500
d	16,000
D	22,000
B	7,700
B1	5,600
C	19,000

MANUFACTURER

[SKF](#)

CALCULATION DATA

Operating temperature min	-20 °C
Operating temperature max	150 °C
Permissible operating temperature, short periods max	170 °C
Maximum shaft surface speed	0,001 m/s