

60 VS V SKF

Axial shaft seals

TYPE: Axial shaft seals, V-ring seals, All-rubber seals, Type VS/VR2, material FPM/FKM (SKF)

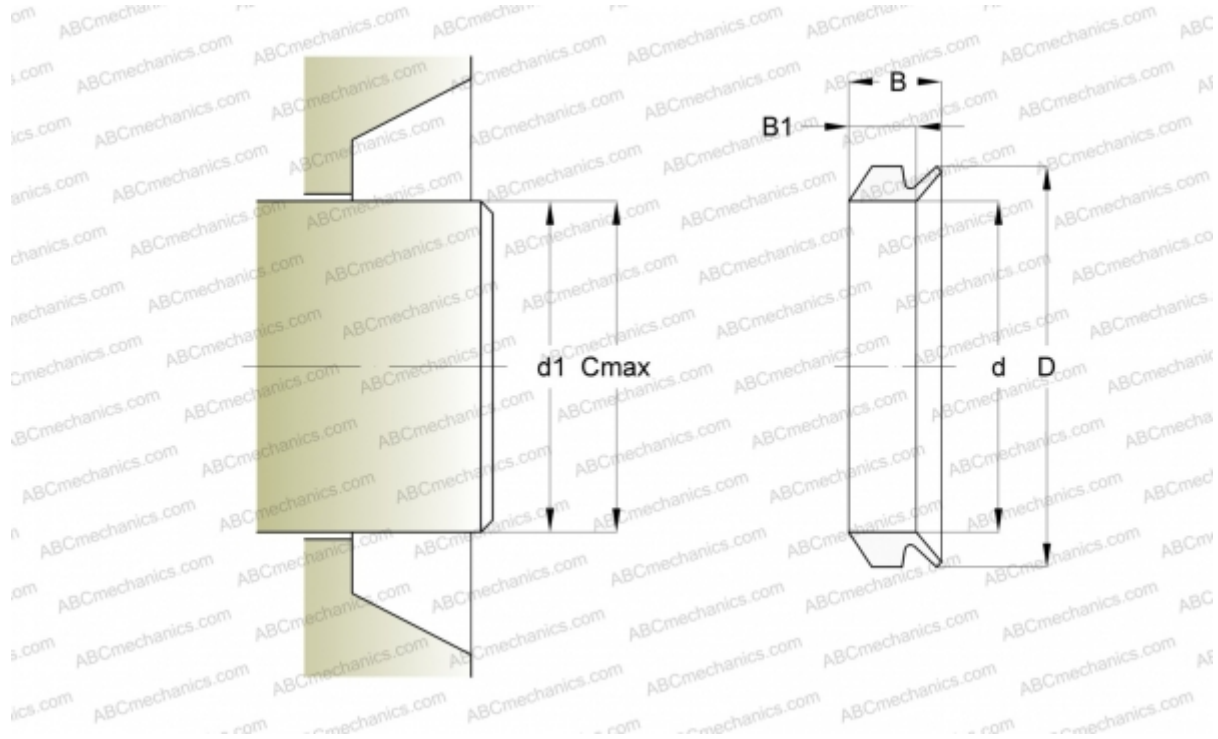

Technical specification

DIMENSIONS, MM

d1	58,000
d	54,000
D	64,000
B	13,000
B1	9,500
C	63,000

MANUFACTURER

[SKF](#)

CALCULATION DATA

Operating temperature min	-20 °C
Operating temperature max	150 °C
Permissible operating temperature, short periods max	170 °C
Maximum shaft surface speed	0,001 m/s