

75 VS V SKF

Axial shaft seals

TYPE: Axial shaft seals, V-ring seals, All-rubber seals, Type VS/VR2, material FPM/FKM (SKF)

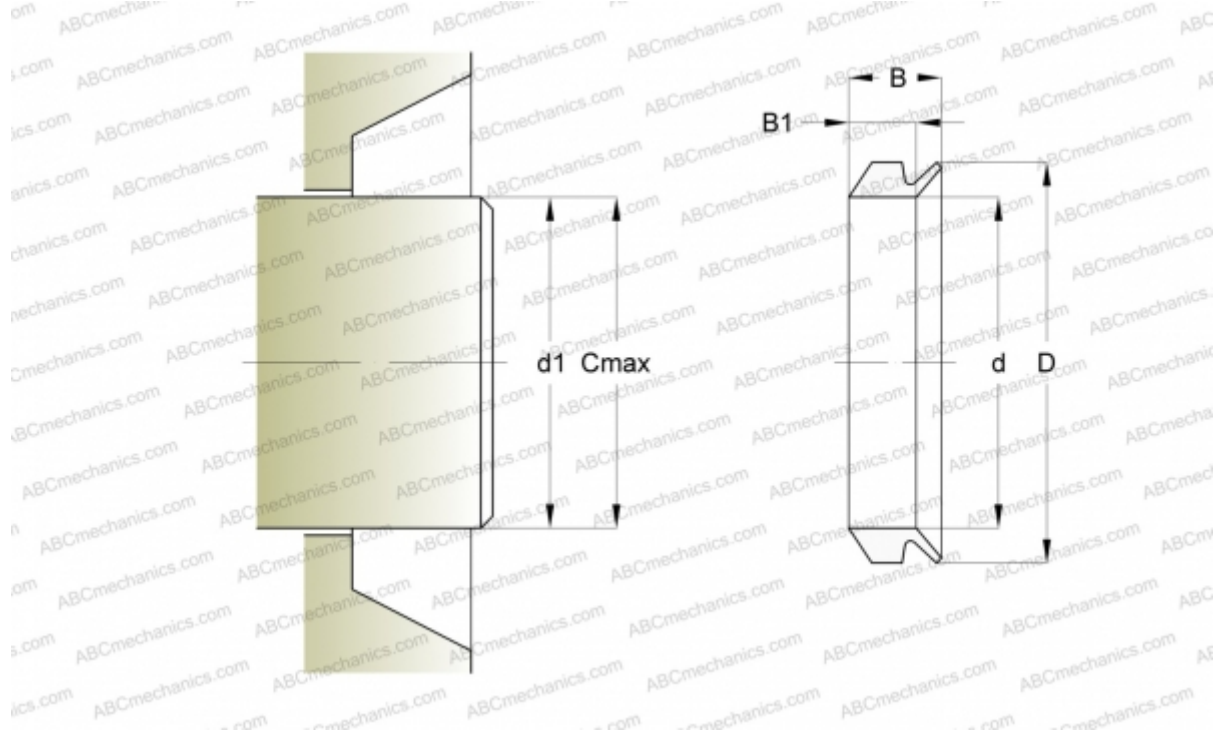

Technical specification

DIMENSIONS, MM

d1	73,000
d	67,000
D	79,000
B	15,500
B1	11,300
C	78,000

MANUFACTURER

[SKF](#)

CALCULATION DATA

Operating temperature min	-20 °C
Operating temperature max	150 °C
Permissible operating temperature, short periods max	170 °C
Maximum shaft surface speed	0,001 m/s