

650 VL R SKF

Axial shaft seals

TYPE: Axial shaft seals, V-ring seals, All-rubber seals, Type VL/VR3, material NBR (SKF)

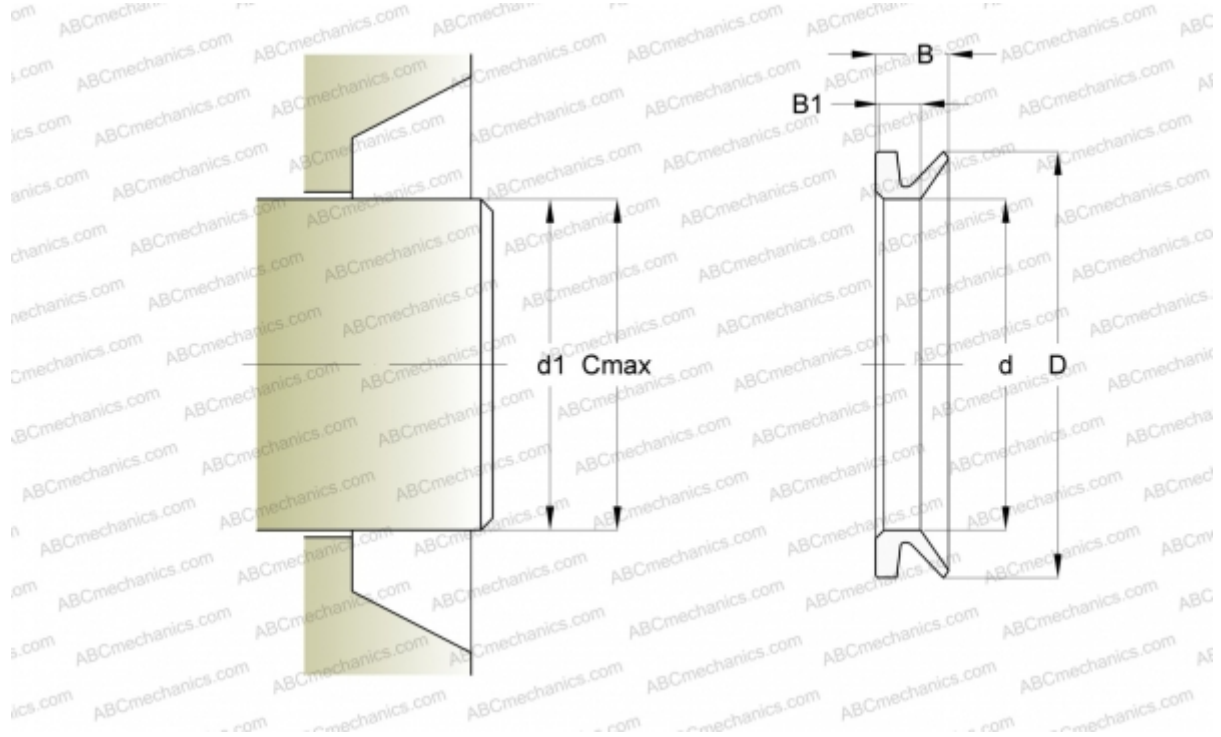

Technical specification

DIMENSIONS, MM

d1	615,000
d	600,000
D	613,000
B	10,500
B1	6,000
C	675,000

MANUFACTURER [SKF](#)

CALCULATION DATA

Operating temperature min	-40 °C
Operating temperature max	100 °C
Permissible operating temperature, short periods max	120 °C
Maximum shaft surface speed	0,001 m/s