

375 VL V SKF

Axial shaft seals

TYPE: Axial shaft seals, V-ring seals, All-rubber seals, Type VL/VR3, material FPM/FKM (SKF)

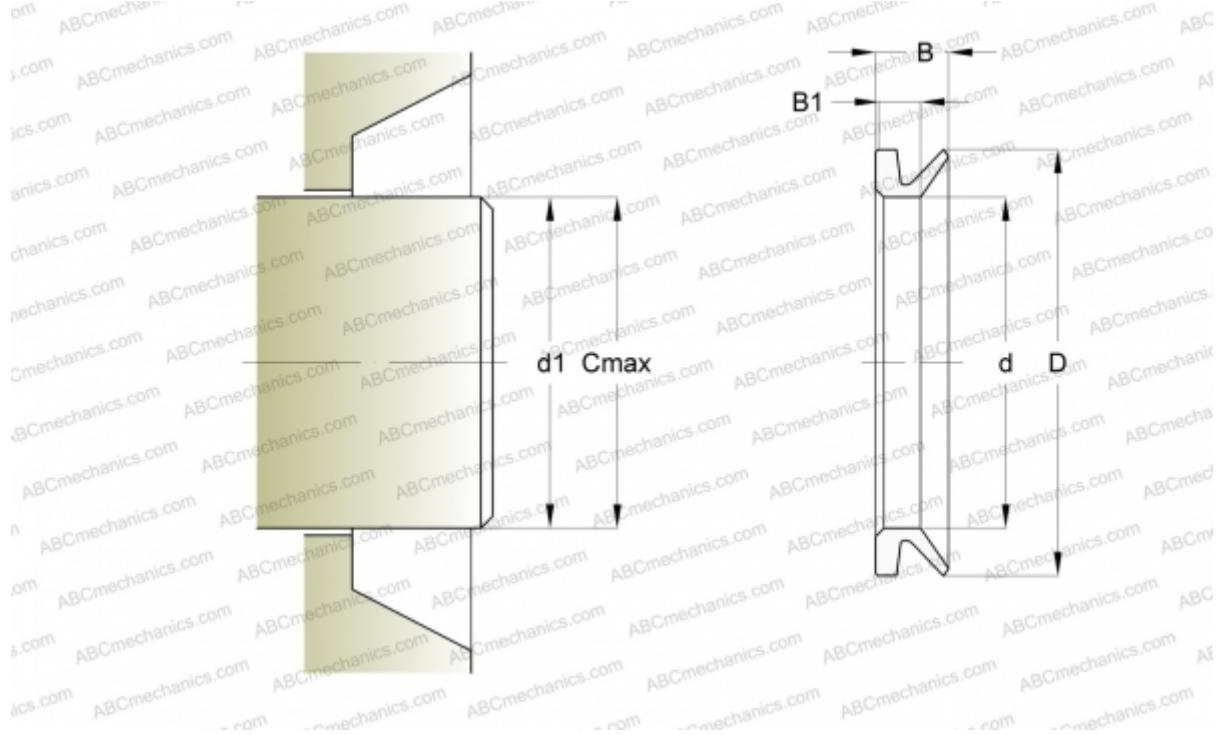

Technical specification

DIMENSIONS, MM

d1	365,000
d	337,000
D	350,000
B	10,500
B1	6,000
C	385,000

MANUFACTURER [SKF](#)

CALCULATION DATA

Operating temperature min	-20 °C
Operating temperature max	150 °C
Permissible operating temperature, short periods max	170 °C
Maximum shaft surface speed	0,001 m/s