

440 VRME R SKF

Axial shaft seals

TYPE: Axial shaft seals, V-ring seals, All-rubber seals, Type VRME/VR6, material NBR (SKF)

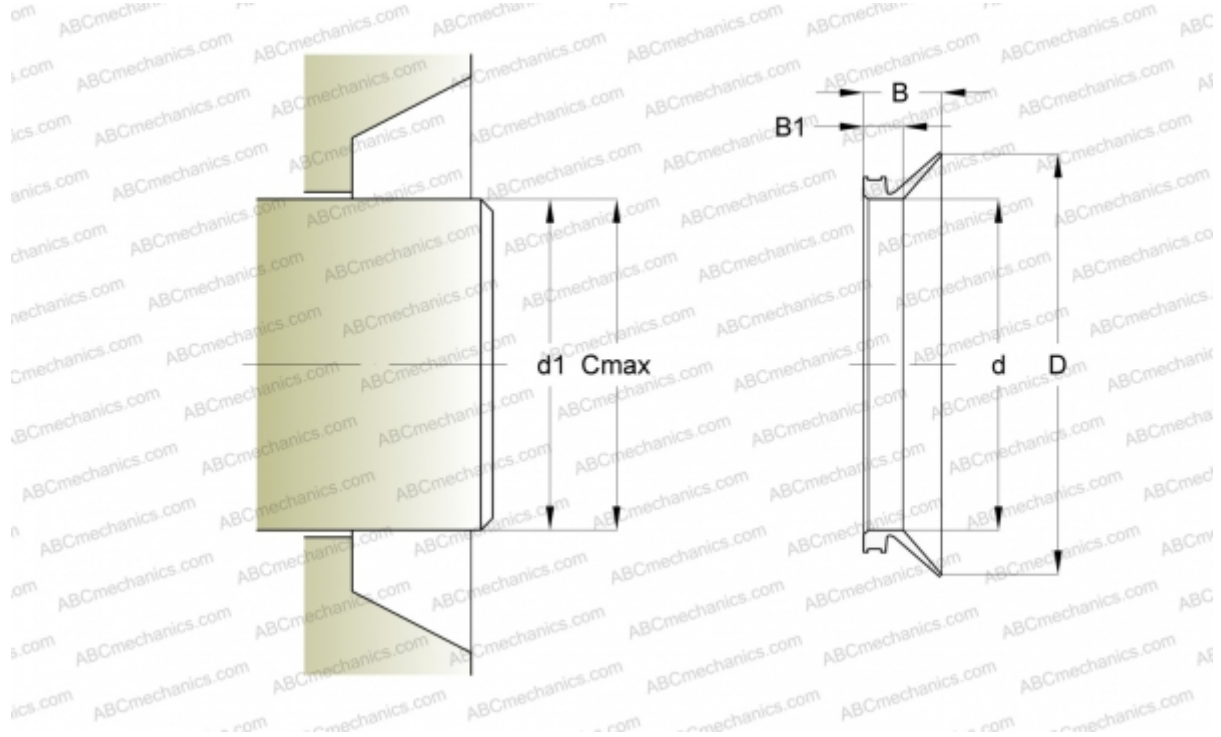

Technical specification

DIMENSIONS, MM

d1	440,000
d	429,000
D	471,000
B	65,000
B1	32,500
C	445,000

MANUFACTURER

[SKF](#)

CALCULATION DATA

Operating temperature min	-40 °C
Operating temperature max	100 °C
Permissible operating temperature, short periods max	120 °C
Maximum shaft surface speed	0,001 m/s