

400101 SKF - USA

Axial shaft seals

TYPE: Axial shaft seals, V-ring seals, All-rubber seals, Type VR2, material NBR (SKF)

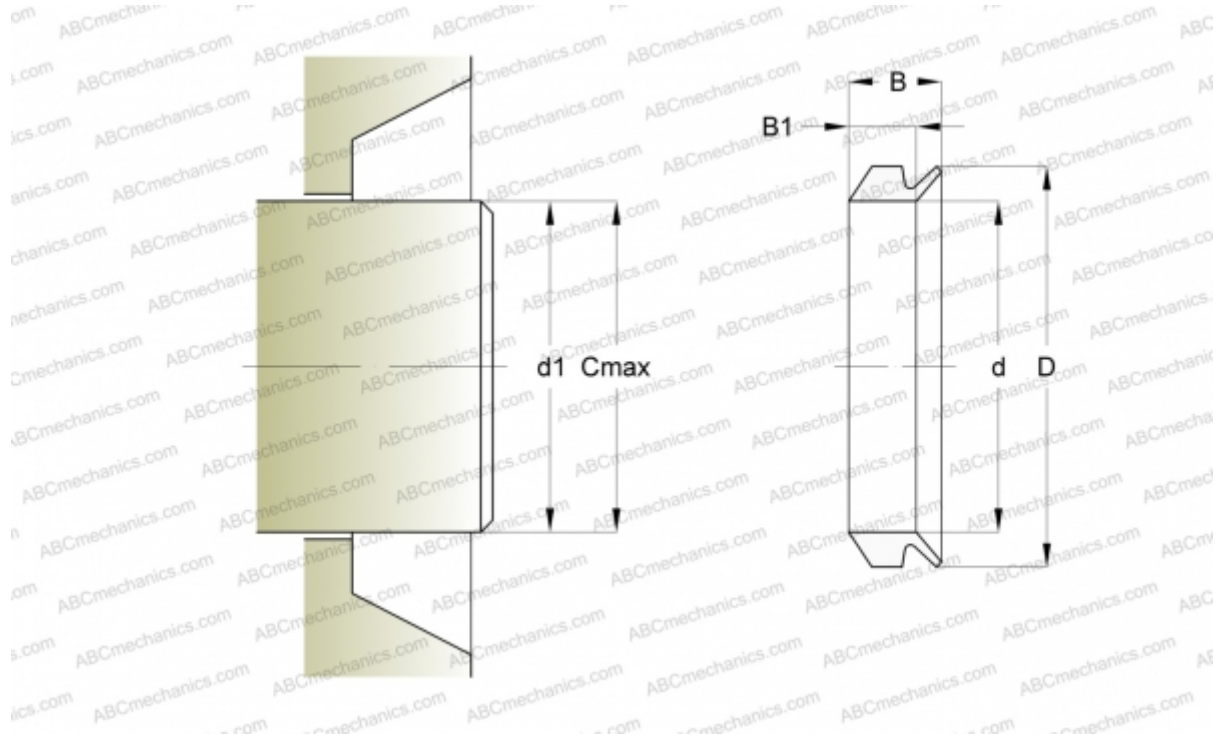

Technical specification

DIMENSIONS, MM

d_1	9,500
d	9,000
D	15,000
B	7,700
B_1	5,600
C	11,500

MANUFACTURER

[SKF - USA](#)

CALCULATION DATA

Operating temperature min	-40 °C
Operating temperature max	100 °C
Permissible operating temperature, short periods max	120 °C
Maximum shaft surface speed	0,001 m/s