

## 400351 SKF - USA

Axial shaft seals

TYPE: Axial shaft seals, V-ring seals, All-rubber seals, Type VR2, material NBR (SKF)

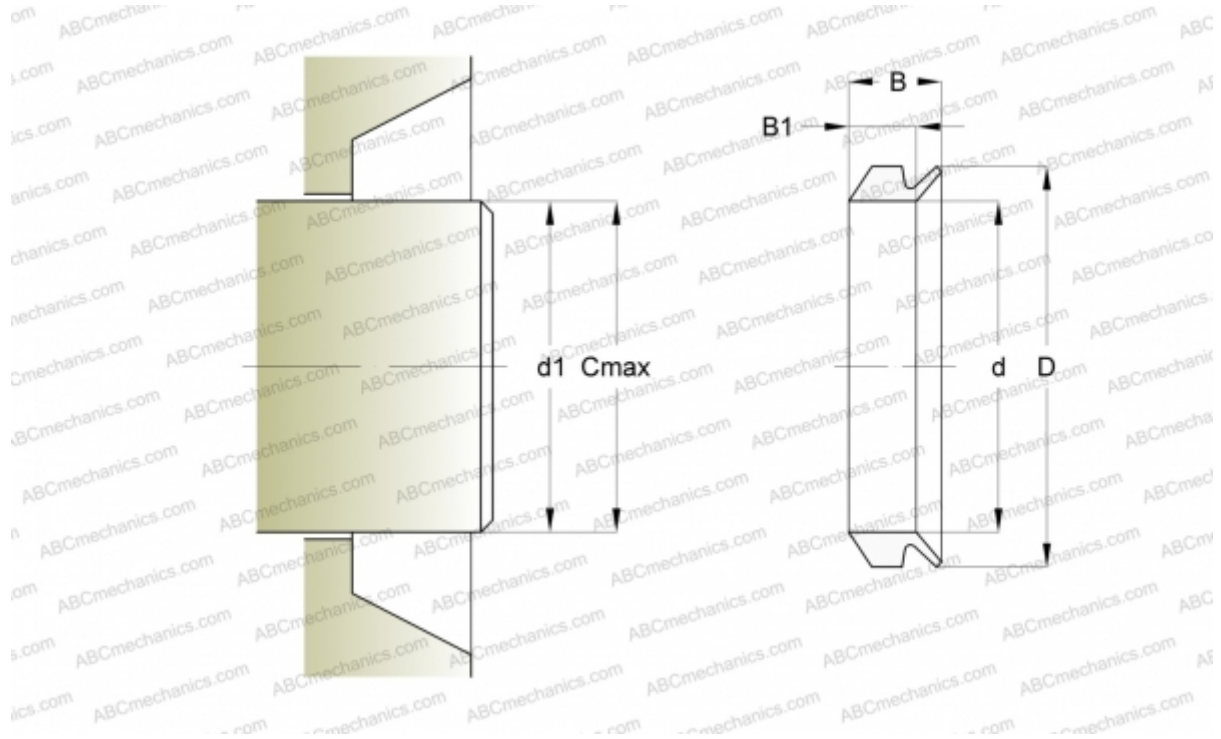

### Technical specification

#### DIMENSIONS, MM

$d_1$	33,000
$d$	31,000
$D$	39,000
$B$	10,500
$B_1$	7,900
$C$	36,000

#### MANUFACTURER

[SKF - USA](#)

#### CALCULATION DATA

Operating temperature min	-40 °C
Operating temperature max	100 °C
Permissible operating temperature, short periods max	120 °C
Maximum shaft surface speed	0,001 m/s