

400955 SKF - USA

Axial shaft seals

TYPE: Axial shaft seals, V-ring seals, All-rubber seals, Type VR2, material FPM/FKM (SKF)

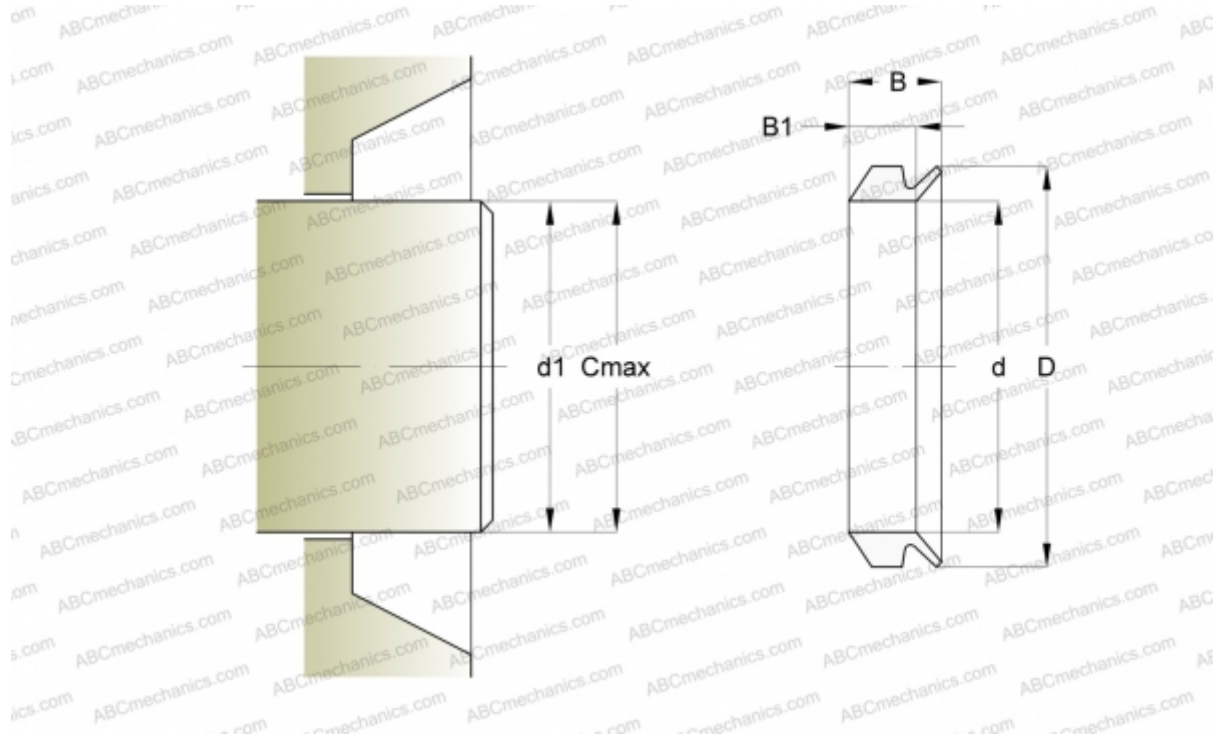

Technical specification

DIMENSIONS, MM

d_1	93,000
d	85,000
D	97,000
B	15,500
B_1	11,300
C	98,000

MANUFACTURER

[SKF - USA](#)

CALCULATION DATA

Operating temperature min	-20 °C
Operating temperature max	150 °C
Permissible operating temperature, short periods max	170 °C
Maximum shaft surface speed	0,001 m/s