

## 401305 SKF - USA

Axial shaft seals

TYPE: Axial shaft seals, V-ring seals, All-rubber seals, Type VR2, material FPM/FKM (SKF)

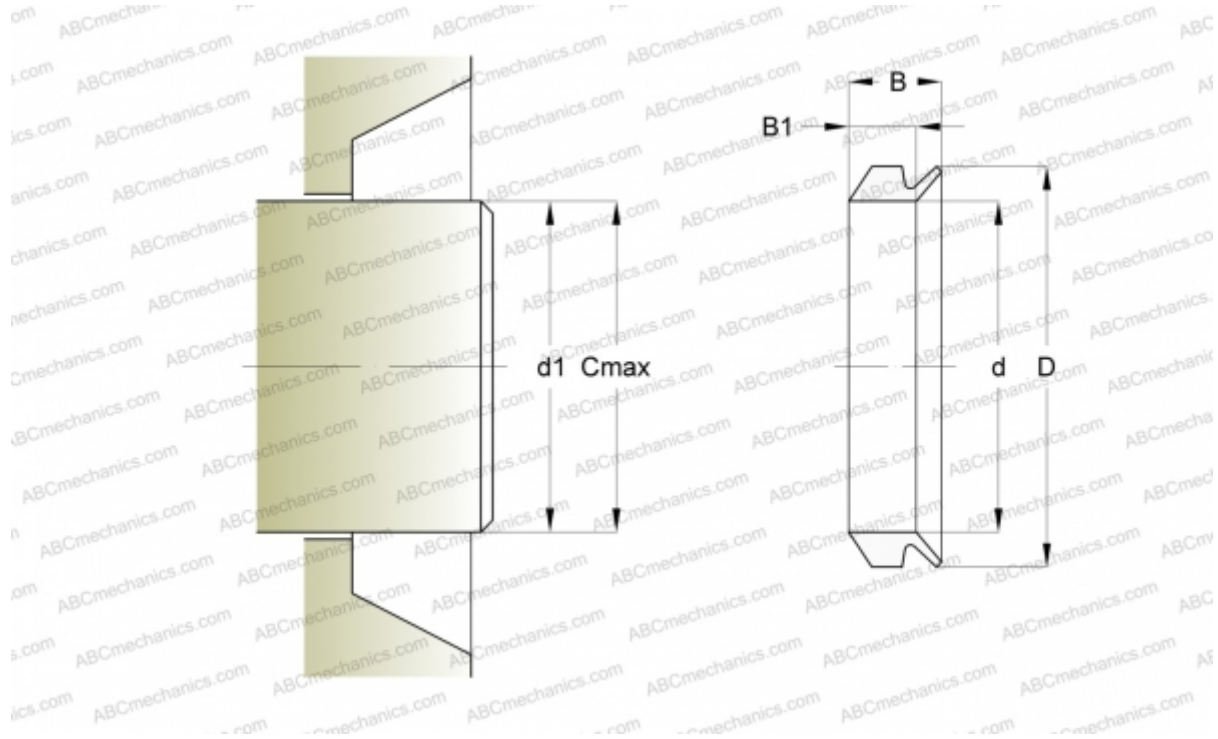

### Technical specification

#### DIMENSIONS, MM

d1	125,000
d	117,000
D	131,000
B	18,000
B1	13,100
C	135,000

#### MANUFACTURER

[SKF - USA](#)

#### CALCULATION DATA

Operating temperature min	-20 °C
Operating temperature max	150 °C
Permissible operating temperature, short periods max	170 °C
Maximum shaft surface speed	0,001 m/s