

401905 SKF - USA

Axial shaft seals

TYPE: Axial shaft seals, V-ring seals, All-rubber seals, Type VR2, material FPM/FKM (SKF)

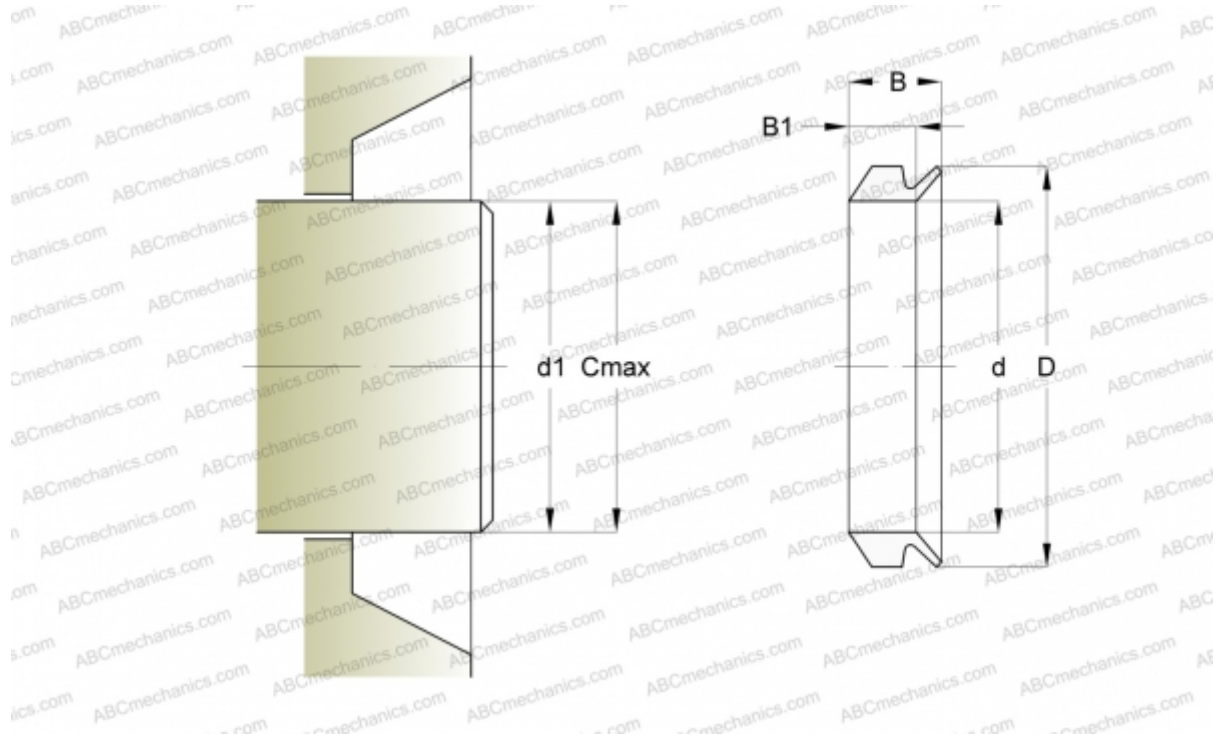

Technical specification

DIMENSIONS, MM

d1	185,000
d	171,000
D	187,000
B	20,500
B1	15,000
C	195,000

MANUFACTURER

[SKF - USA](#)

CALCULATION DATA

Operating temperature min	-20 °C
Operating temperature max	150 °C
Permissible operating temperature, short periods max	170 °C
Maximum shaft surface speed	0,001 m/s