

## 401995 SKF - USA

Axial shaft seals

TYPE: Axial shaft seals, V-ring seals, All-rubber seals, Type VR2, material FPM/FKM (SKF)

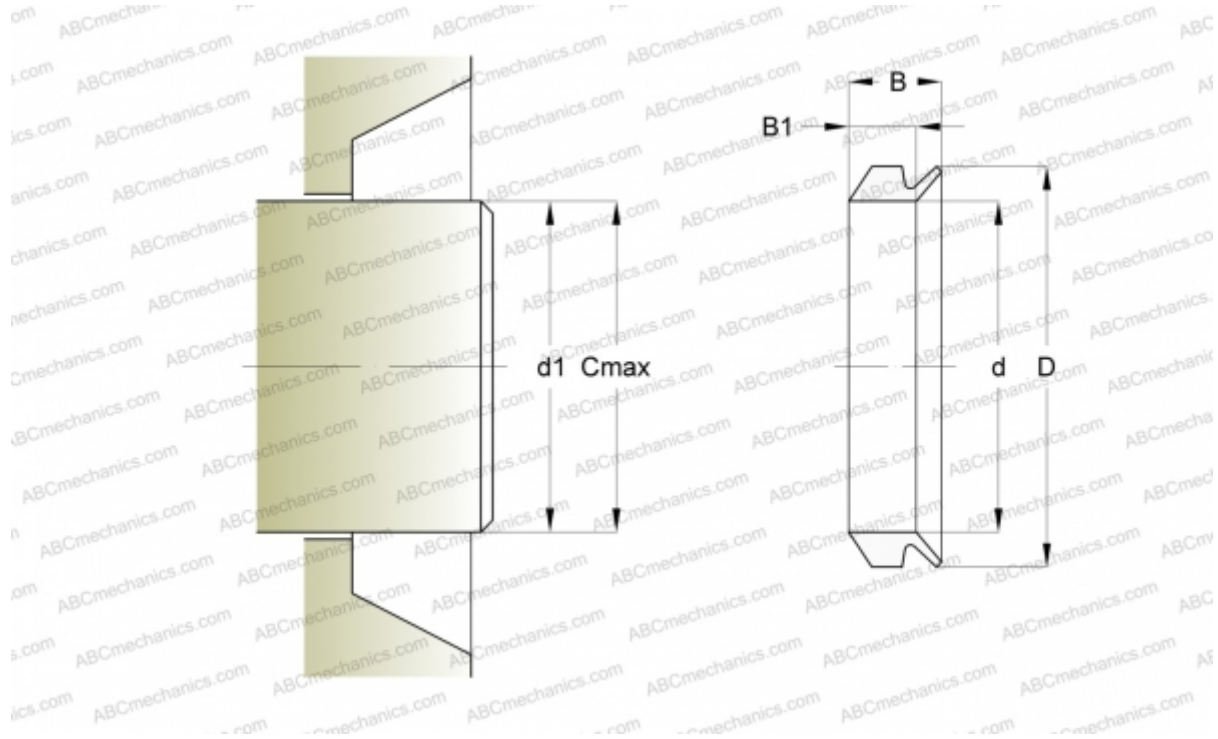

### Technical specification

#### DIMENSIONS, MM

$d_1$	195,000
$d$	180,000
$D$	196,000
$B$	20,500
$B_1$	15,000
$C$	210,000

#### MANUFACTURER

[SKF - USA](#)

#### CALCULATION DATA

Operating temperature min	-20 °C
Operating temperature max	150 °C
Permissible operating temperature, short periods max	170 °C
Maximum shaft surface speed	0,001 m/s