

470536 SKF - USA

Axial shaft seals

TYPE: Axial shaft seals, V-ring seals, All-rubber seals, Type VR6, material NBR (SKF)

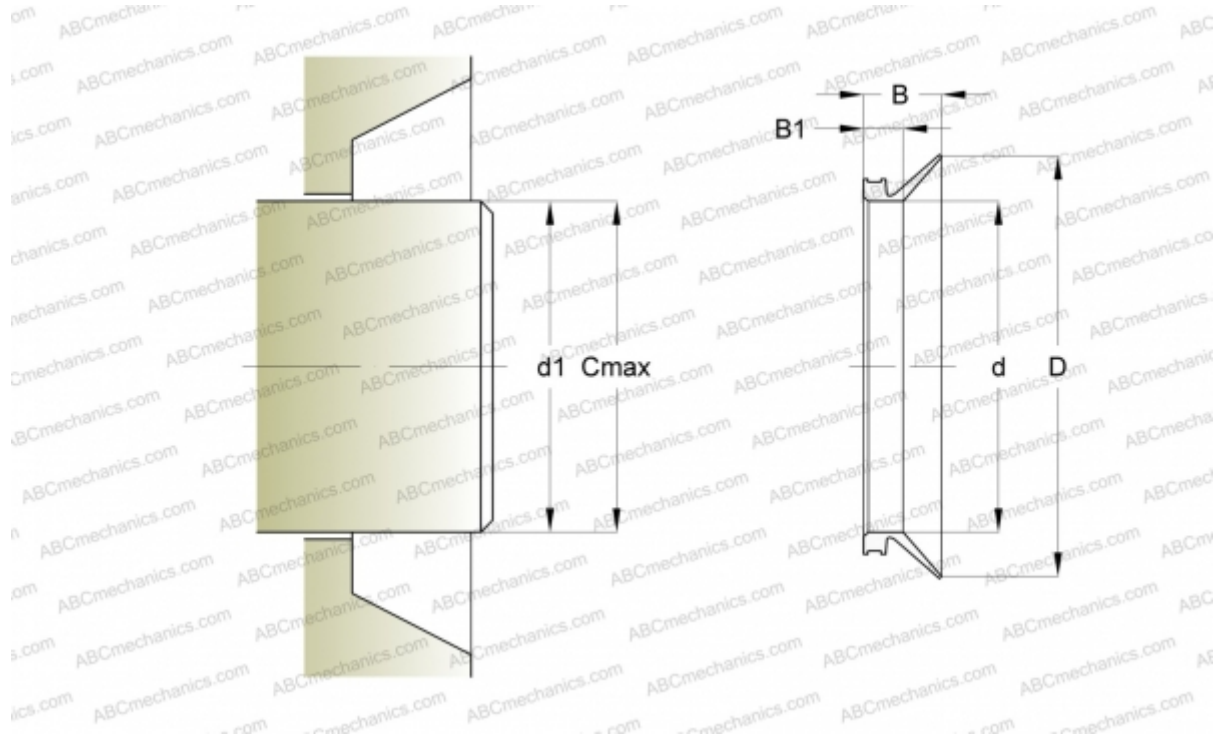

Technical specification

DIMENSIONS, MM

d1	535,000
d	521,000
D	563,000
B	65,000
B1	32,500
C	540,000

MANUFACTURER

[SKF - USA](#)

CALCULATION DATA

Operating temperature min	-40 °C
Operating temperature max	100 °C
Permissible operating temperature, short periods max	120 °C
Maximum shaft surface speed	0,001 m/s