

MVR2-17 SKF

Axial shaft seals

TYPE: Axial shaft seals, V-ring seals, Metal-cased V-ring seals, Type MVR2 (SKF)

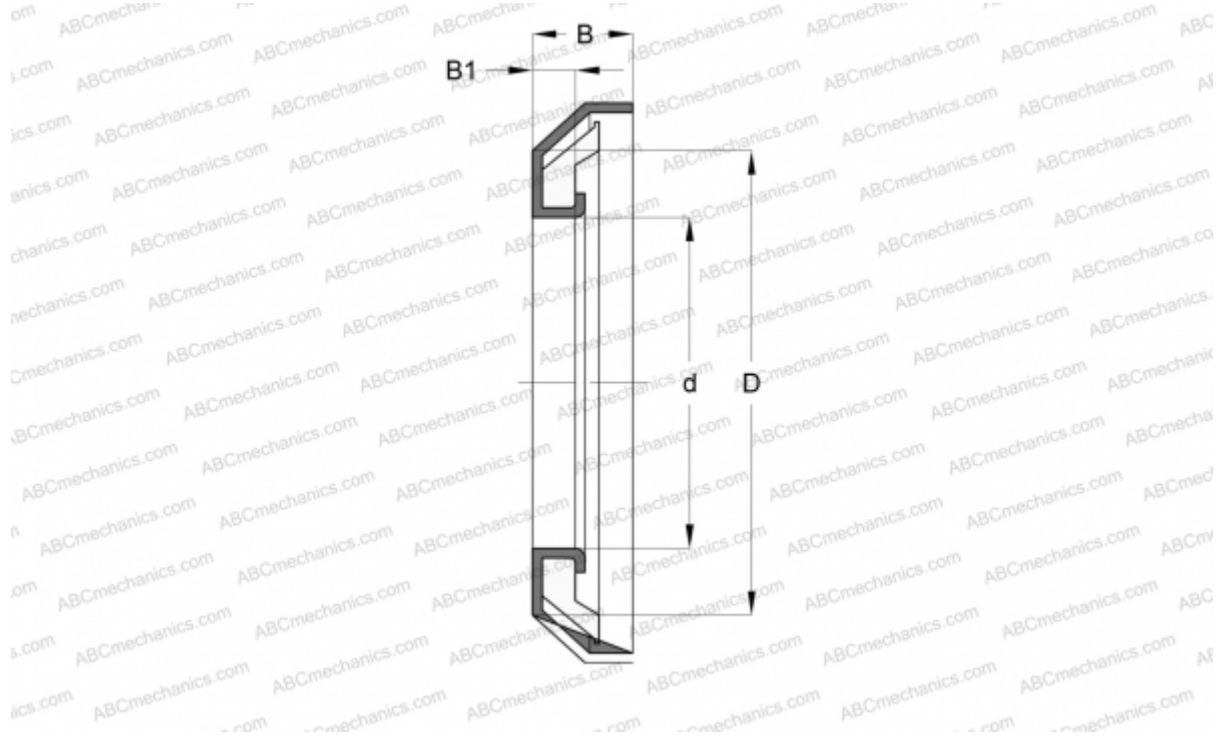

Technical specification

DIMENSIONS, MM

d1	17,000
d	17,000
D	34,000
B	6,000
B1	4,000

MANUFACTURER

[SKF](#)

CALCULATION DATA

Operating temperature min	-50 °C
Operating temperature max	100 °C
Permissible operating temperature, short periods max	120 °C
Pressure differential max	0,200 Mpa
Maximum shaft surface speed	1,750 m/s