

## MVR2-95 SKF

Axial shaft seals

TYPE: Axial shaft seals, V-ring seals, Metal-cased V-ring seals, Type MVR2 (SKF)

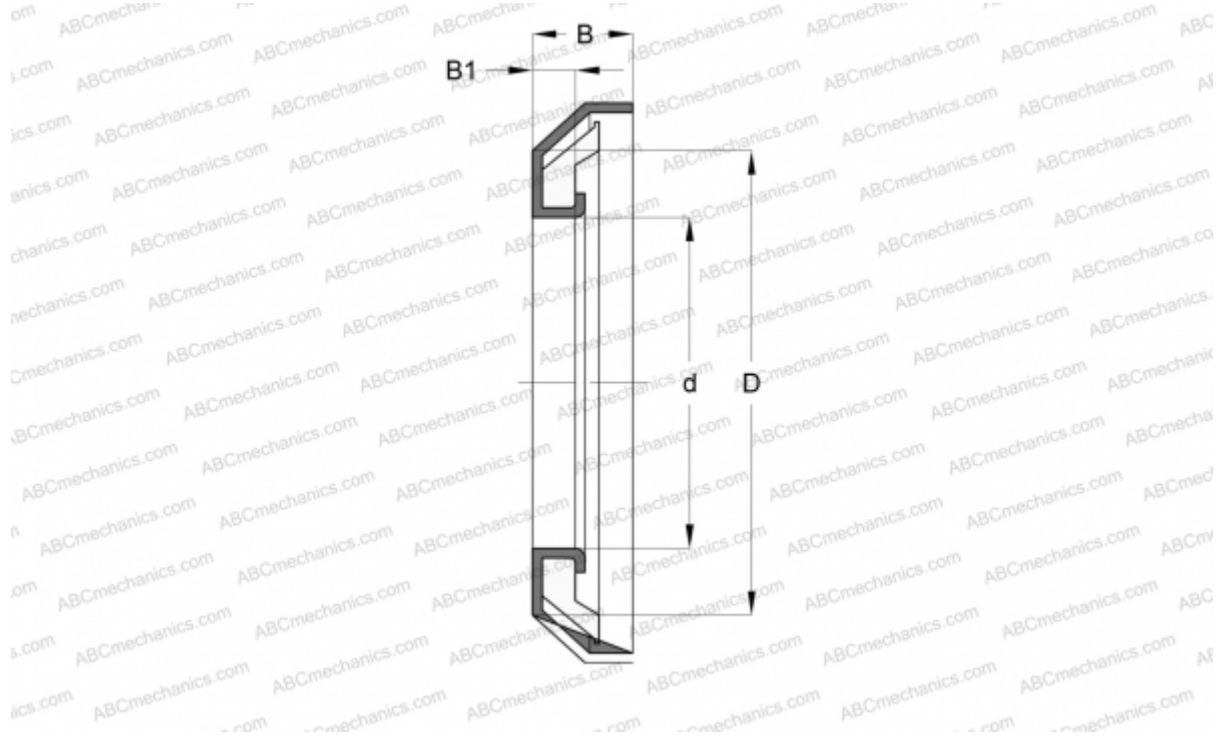

### Technical specification

#### DIMENSIONS, MM

d1	95,000
d	95,000
D	117,000
B	7,500
B1	5,500

#### MANUFACTURER

[SKF](#)

#### CALCULATION DATA

Operating temperature min	-50 °C
Operating temperature max	100 °C
Permissible operating temperature, short periods max	120 °C
Pressure differential max	0,200 Mpa
Maximum shaft surface speed	1,750 m/s