

## 524347 SKF

Axial shaft seals

TYPE: Axial shaft seals, Axial clamp seals, Type CT1, material NBR (SKF)

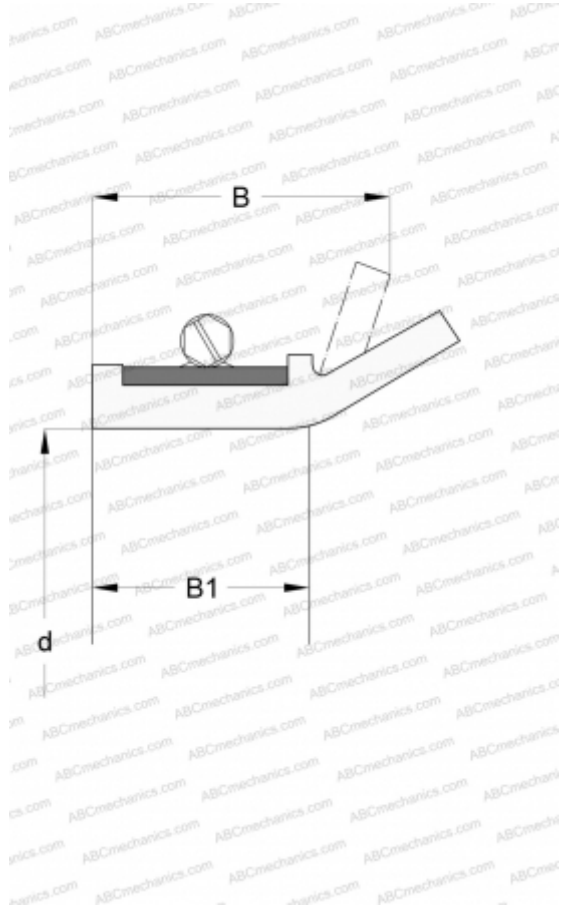

### Technical specification

#### DIMENSIONS, MM

d1	559,000
d	559,000
B	31,800
B1	20,700

#### MANUFACTURER

[SKF](#)

#### CALCULATION DATA

Operating temperature min	-50 °C
Operating temperature max	100 °C
Permissible operating temperature, short periods max	120 °C
Pressure differential max	0,200 Mpa
Maximum shaft surface speed	1,750 m/s