

592934 SKF

Axial shaft seals

TYPE: Axial shaft seals, Axial clamp seals, Type CT4, material NBR (SKF)

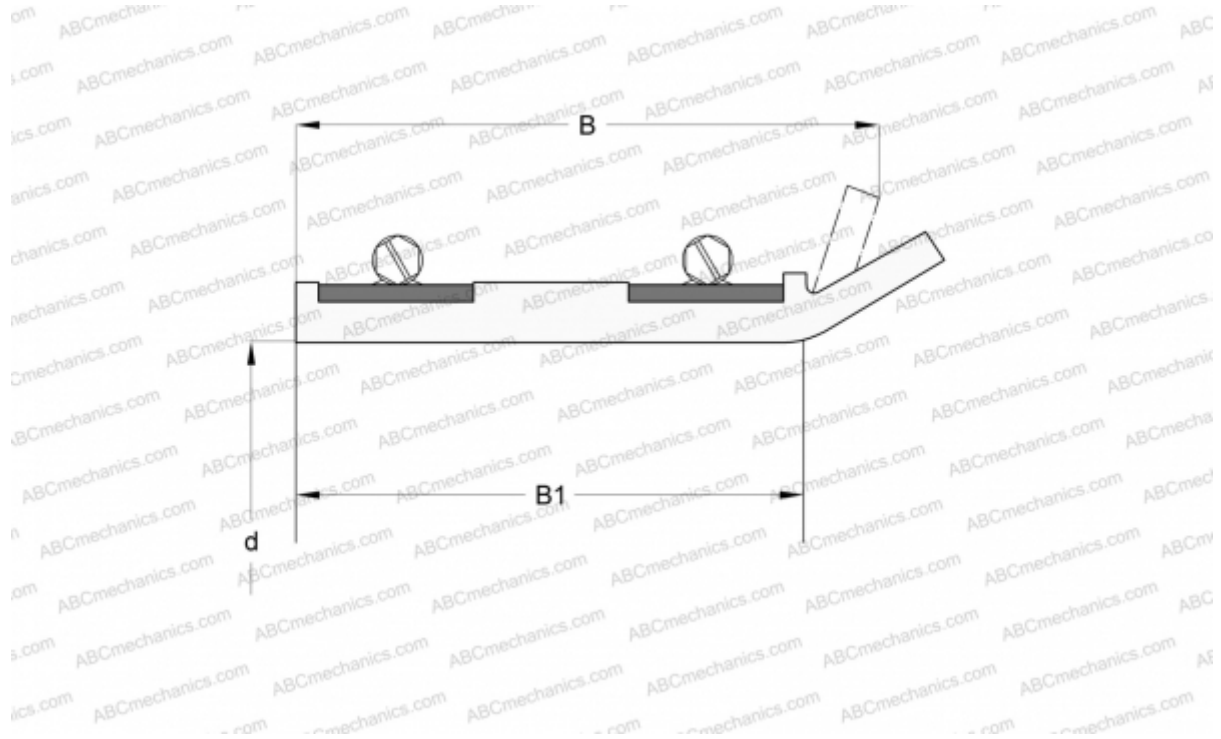

Technical specification

DIMENSIONS, MM

d1	413,000
d	413,000
B	88,900
B1	77,800

MANUFACTURER [SKF](#)

CALCULATION DATA

Operating temperature min	-50 °C
Operating temperature max	100 °C
Permissible operating temperature, short periods max	120 °C
Pressure differential max	0,200 Mpa
Maximum shaft surface speed	1,750 m/s