

## 334679 SIMRIT

Radial shaft seals

TYPE: Radial shaft seals, Metal case, With spring-loaded sealing lip, Type B1FUD, material 72 NBR 902 (SIMRIT)

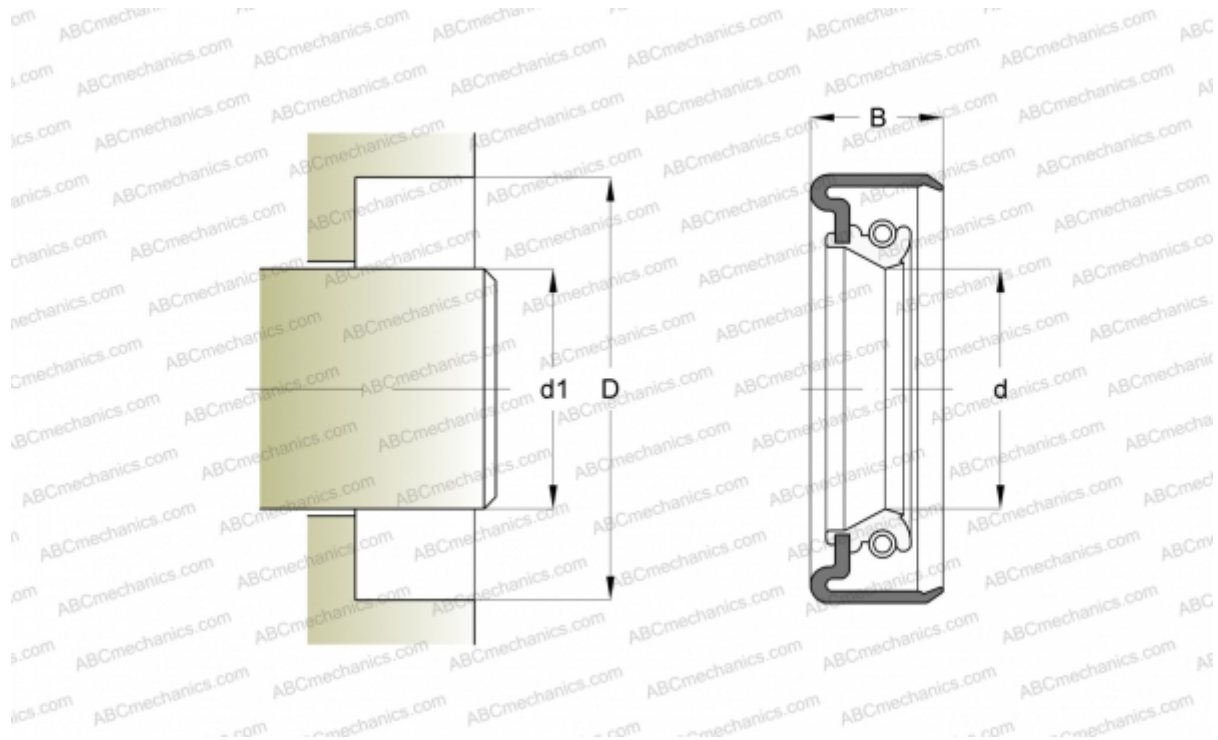

### Technical specification

#### DIMENSIONS, MM

$d_1$	45,000
$d$	45,000
$D$	60,000
$B$	10,000

#### MANUFACTURER

[SIMRIT](#)

#### CALCULATION DATA

Operating temperature min	-40 °C
Operating temperature max	100 °C
Permissible operating temperature, short periods max	120 °C
Pressure differential max	0,020 Mpa
Maximum shaft surface speed	10,000 m/s

#### REPLACES

B1FUD 45-60-10 72 NBR 902 (334679)