

334932 SIMRIT

Radial shaft seals

TYPE: Radial shaft seals, Metal case, With spring-loaded sealing lip, Type B1FUD, material 72 NBR 902 (SIMRIT)

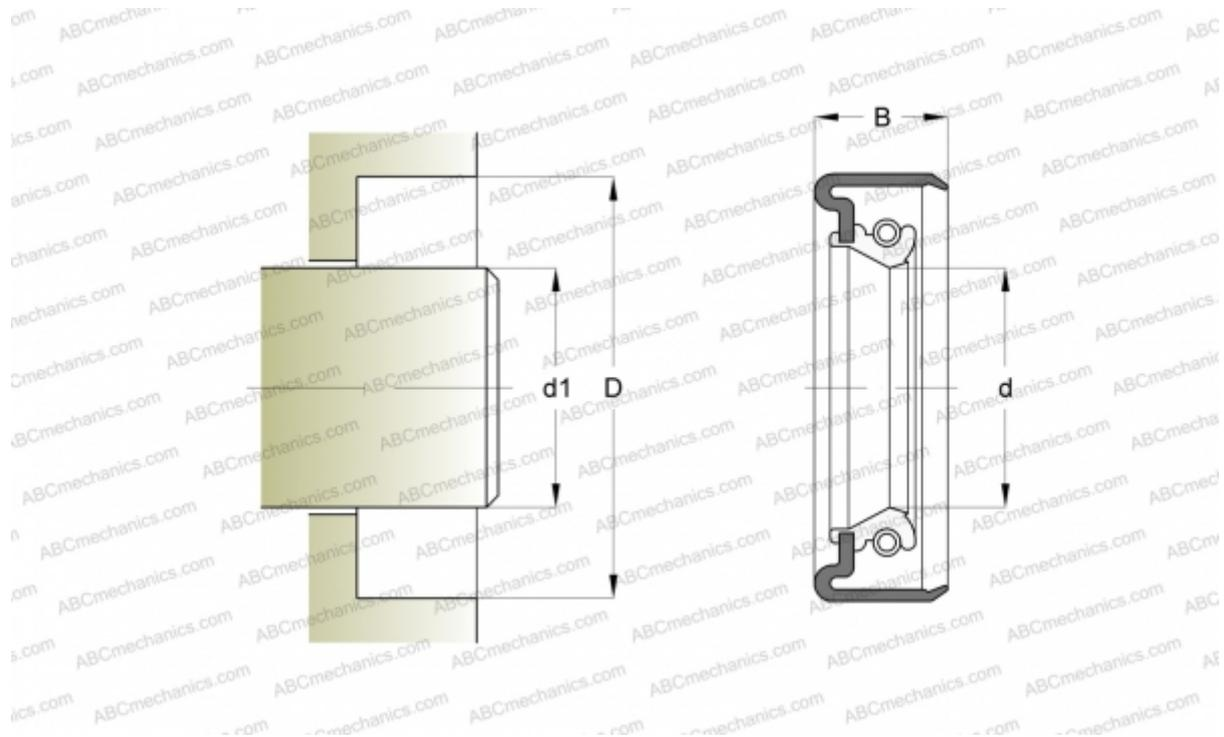

Technical specification

DIMENSIONS, MM

d_1	60,000
d	60,000
D	80,000
B	12,000

MANUFACTURER

[SIMRIT](#)

CALCULATION DATA

Operating temperature min	-40 °C
Operating temperature max	100 °C
Permissible operating temperature, short periods max	120 °C
Pressure differential max	0,020 Mpa
Maximum shaft surface speed	10,000 m/s

REPLACES

B1FUD 60-80-12 72 NBR 902 (334932)