

335120 SIMRIT

Radial shaft seals

TYPE: Radial shaft seals, Metal case, With spring-loaded sealing lip, Type B1FUDSL, material 72 NBR 902 (SIMRIT)

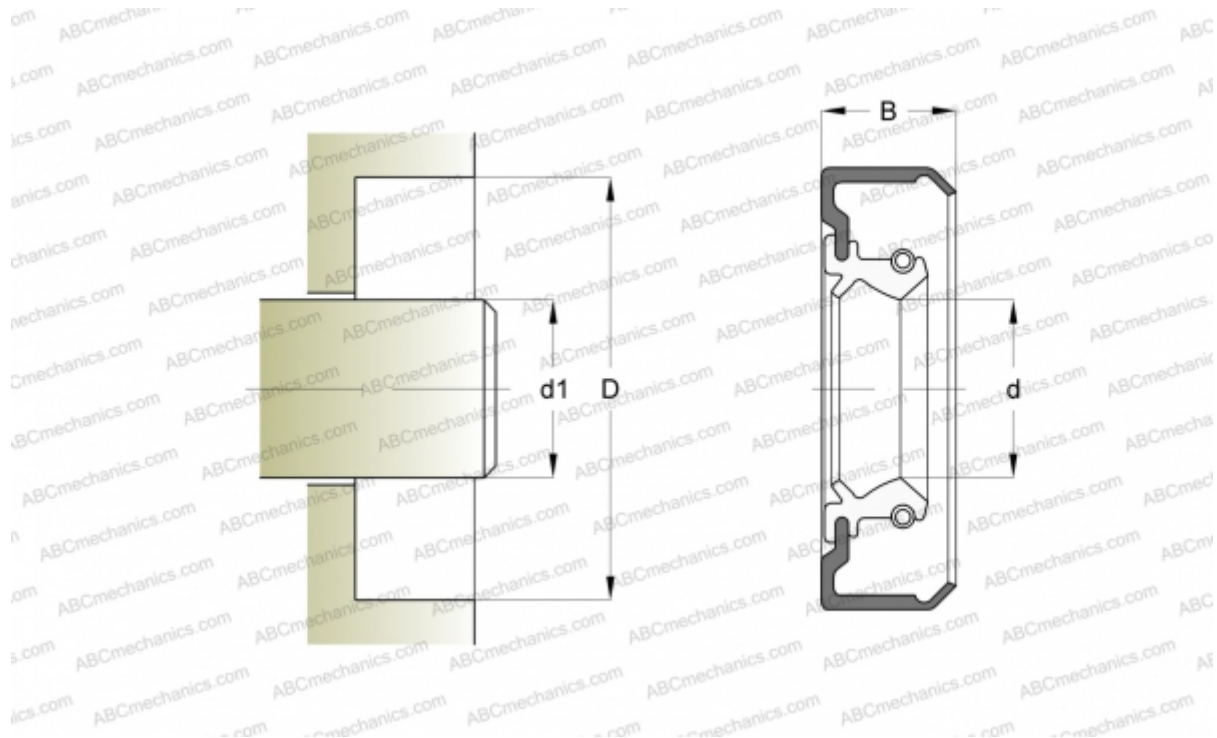

Technical specification

DIMENSIONS, MM

d1	68,000
d	68,000
D	90,000
B	13,000

MANUFACTURER [SIMRIT](#)

CALCULATION DATA

Operating temperature min	-40 °C
Operating temperature max	100 °C
Permissible operating temperature, short periods max	120 °C
Pressure differential max	0,020 Mpa
Maximum shaft surface speed	10,000 m/s

REPLACES

B1FUDSL 68-90-13 72 NBR 902 (335120)