

31467 SIMRIT

Radial shaft seals

TYPE: Radial shaft seals, Metal case, With spring-loaded sealing lip, Type B1U5L, material 72 NBR 902 (SIMRIT)

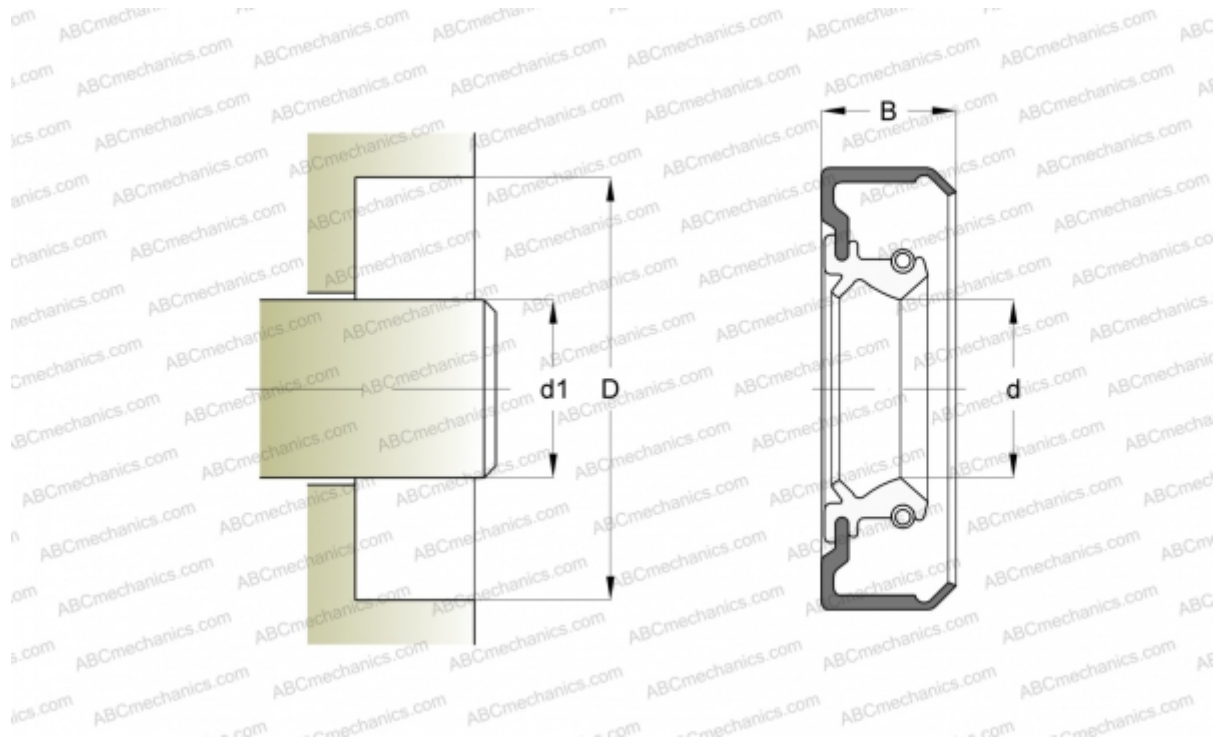

Technical specification

DIMENSIONS, MM

d1	42,000
d	42,000
D	62,000
B	12,000

MANUFACTURER [SIMRIT](#)

CALCULATION DATA

Operating temperature min	-40 °C
Operating temperature max	100 °C
Permissible operating temperature, short periods max	120 °C
Pressure differential max	0,050 Mpa
Maximum shaft surface speed	10,000 m/s

REPLACES

B1U5L 42-62-12 72 NBR 902 (31467)