

33356 SIMRIT

Radial shaft seals

TYPE: Radial shaft seals, Metal case, With spring-loaded sealing lip, Type B1USL, material 72 NBR 902 (SIMRIT)

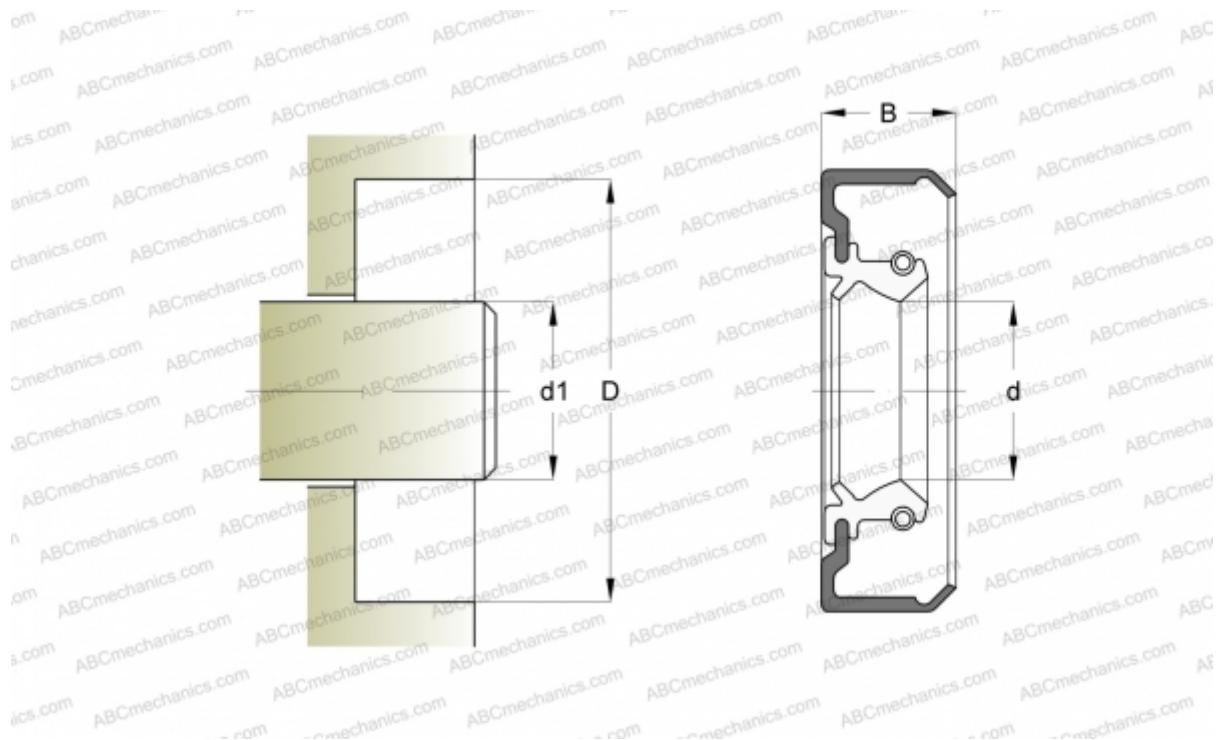

Technical specification

DIMENSIONS, MM

$d1$	110,000
d	110,000
D	128,000
B	9,000

MANUFACTURER

[SIMRIT](#)

CALCULATION DATA

Operating temperature min	-40 °C
Operating temperature max	100 °C
Permissible operating temperature, short periods max	120 °C
Pressure differential max	0,050 Mpa
Maximum shaft surface speed	10,000 m/s

REPLACES

B1USL 110-128-9 72 NBR 902 (33356)