

361194 SIMRIT

Radial shaft seals

TYPE: Radial shaft seals, Metal case, With spring-loaded sealing lip, Type B1SL, material 72 NBR 902 (SIMRIT)

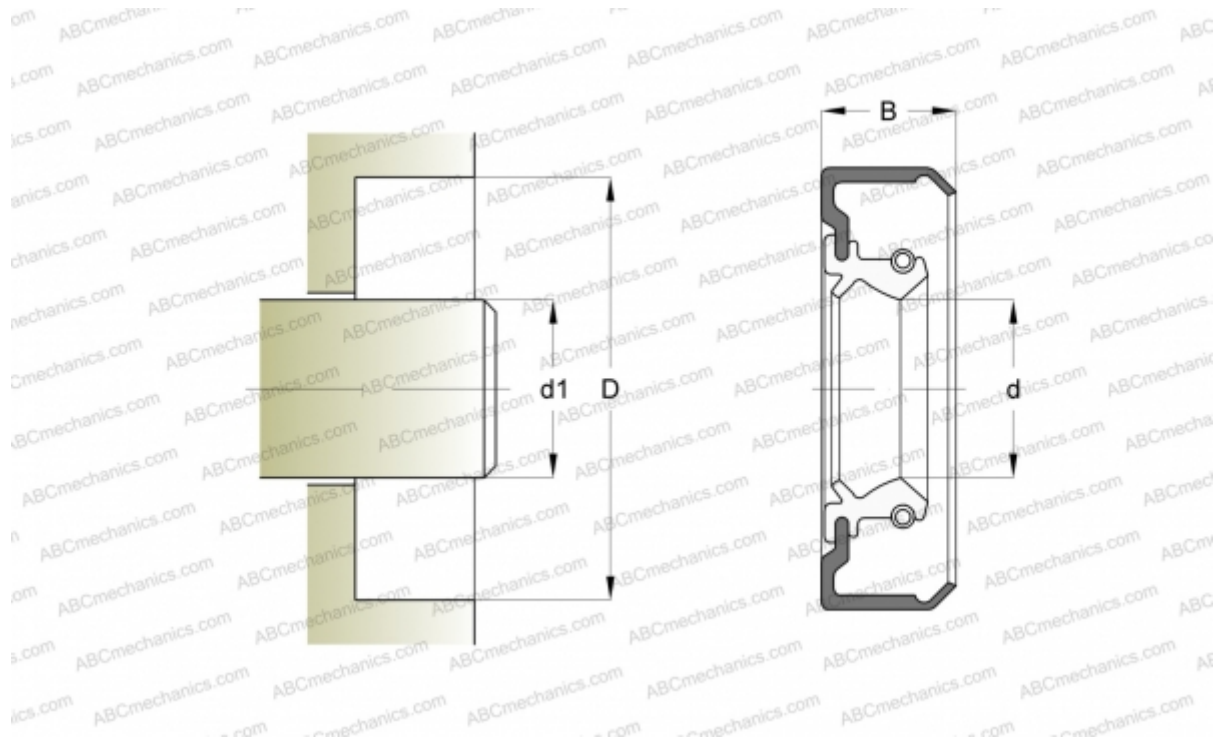

Technical specification

DIMENSIONS, MM

d1	18,000
d	18,000
D	30,000
B	7,000

MANUFACTURER [SIMRIT](#)

CALCULATION DATA

Operating temperature min	-40 °C
Operating temperature max	100 °C
Permissible operating temperature, short periods max	120 °C
Pressure differential max	0,050 Mpa
Maximum shaft surface speed	10,000 m/s

REPLACES

B1SL 18-30-7 72 NBR 902 (361194)