

## 20158 SIMRIT

Radial shaft seals

TYPE: Radial shaft seals, Metal case, With spring-loaded sealing lip, Type B1SL, material 72 NBR 902 (SIMRIT)

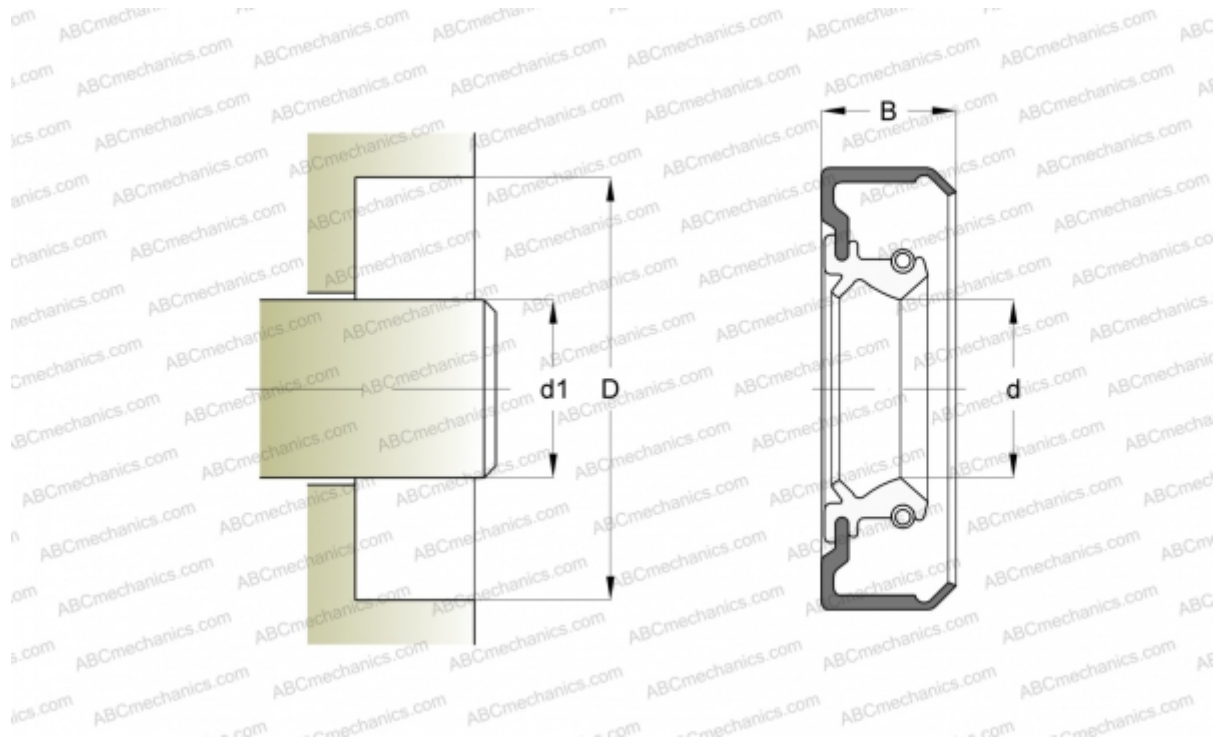

### Technical specification

#### DIMENSIONS, MM

d1	60,000
d	60,000
D	80,000
B	13,000

#### MANUFACTURER

[SIMRIT](#)

#### CALCULATION DATA

Operating temperature min	-40 °C
Operating temperature max	100 °C
Permissible operating temperature, short periods max	120 °C
Pressure differential max	0,050 Mpa
Maximum shaft surface speed	10,000 m/s

#### REPLACES

B1SL 60-80-13 72 NBR 902 (20158)